

# DGT1SX

High-speed digital weight transmitter

USER MANUAL

ENGLISH

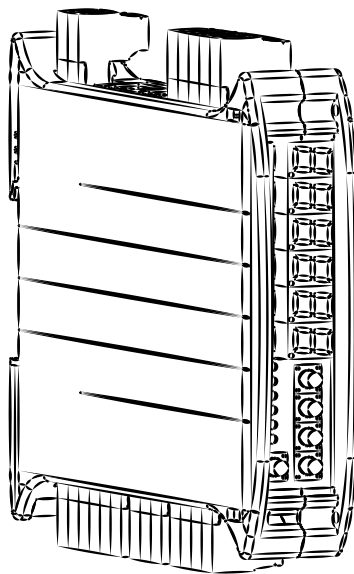



<b>Introduction</b>	<b>7</b>
<b>Transmitter installation</b>	<b>8</b>
Installation requirements	8
Electrical precautions	9
Earthing of the system	11
Technical features	14
Load cell installation	15
<b>Wiring diagrams</b>	<b>16</b>
DGT1SX	16
DGT1SX-AN	17
DGT1SX-PB	18
DGT1SX-ETHIP, DGT1SX-ETHCAT, DGT1SX-PRONET, DGT1SX-MODTCP	19
DGT1SX-CANOP	20
DGT1SX-DEVNET	21
<b>Display and function of the keys</b>	<b>22</b>
<b>Quick menu</b>	<b>22</b>
<b>Advanced programming menu</b>	<b>23</b>
Access to the advanced menu and saving the changes	23
Function of the keys in the menu	23
Block diagram of the menu	24
<b>Theoretical calibration</b>	<b>26</b>
<b>Calibration with sample weights</b>	<b>27</b>
<b>Manual calibration</b>	<b>29</b>
<b>Quick zero calibration (pre-tare reset)</b>	<b>29</b>
<b>ADC converter precalibration</b>	<b>30</b>

<b>Filter and stability</b>	<b>30</b>
Filter adjustment	30
Anti-peak filter	31
Stability detection sensitivity	31
<b>Gravity</b>	<b>32</b>
<b>Reset functions and parameters</b>	<b>33</b>
Auto-zeroing on start-up	33
Maximum percentage of manual zeroing	33
Zero tracking	33
Restoring zero	34
Semi-automatic zeroing	34
<b>Tare functions and parameters</b>	<b>34</b>
Tare mode	34
Semi-automatic tare	34
Predetermined tare	35
Clearing the tare	35
Restoring the tare	35
<b>Alibi memory</b>	<b>36</b>
Enabling the alibi memory	36
Saving a weighing operation in the alibi memory	36
Reading the alibi memory	37
Initialising the alibi memory	37
<b>Use functions</b>	<b>38</b>
High resolution	38
Peak detection	38
Converting units of measurement	38
Alibi memory	38
No function	38
<b>Input configuration</b>	<b>39</b>
<b>Output configuration</b>	<b>40</b>
<b>Analog output configuration</b>	<b>41</b>

<b>Serial communication configuration</b>	<b>43</b>
Configuration of the USB port	43
Configuration of the 485 port (PC port)	44
Transmission mode	44
Baud rate, parity, data bits, stop bits	44
<b>Communication protocols</b>	<b>45</b>
Standard string	45
Extended string	45
Serial commands	46
Modbus Protocol	49
<b>Diagnostics</b>	<b>51</b>
Cells / converter test	51
Firmware release	51
Serial number	51
Display	51
Keypad	51
Serial ports	52
Inputs	52
Outputs	52
Analog output (mod. DGT1SX-AN)	52
<b>Programming the Setpoints</b>	<b>52</b>
<b>Restoring factory settings</b>	<b>53</b>
<b>Date and time setting</b>	<b>53</b>
<b>Alarms</b>	<b>54</b>



# Introduction

Dear Customer,  
Thank you for purchasing a DINI ARGEO product.

This manual contains all the instructions for a correct installation and commissioning of the high speed DGT1SX digital weight transmitter. While thanking you for purchasing this product, we would like to draw your attention to some aspects of this manual.

This booklet provides useful information for the correct operation and maintenance of the scale to which it refers;

it is therefore essential to pay the greatest attention to all those paragraphs that illustrate the simplest and safest way to operate.

It is recommended that you carefully follow the instructions for programming the weight transmitter; performing actions not indicated in this manual could compromise the proper functioning of the scale.

The utmost care has been taken in compiling this manual, but reports of any inaccuracies are always welcome.

The transmitter is covered by warranty and **MUST NOT BE TAMPERED WITH BY THE USER** under any circumstances. Any attempt at repair or modification may expose the user to the danger of electric shock and voids any warranty conditions, relieving the Manufacturer from all liability.

Any problem with the product must be reported to the manufacturer or to the retailer where it was purchased. In any case, always **TURN OFF THE POWER SUPPLY** before any installation or repair operation.

## Installation requirements

Observe the following conditions for correct installation of the transmitter and of the load receiver:

- Flat, level support surface.
- Stability and absence of vibrations.
- Absence of aggressive dusts and vapours.
- Absence of draughts.
- Make sure that the platform is levelled or that the load cells are evenly supported.
- Moderate temperature and humidity (15°C - 30°C and 40% - 70%).
- Do not install in an environment where there is a risk of explosion.
- All transmitter connections must be made in accordance with applicable regulations in the area and environment of installation. Observe the electrical precautions listed in the section “**Electrical precautions**”.
- Ensure that it is correctly earthed, see the relevant section “**Earthing of the system**”.
- Do not perform welding when the load cells have already been installed.
- If necessary, use watertight sheaths and fittings to protect the load cell cables.
- Any junction boxes must be watertight.
- Anything not expressly described in this manual constitutes improper use of the equipment.



## Electrical precautions

- Use a regulated mains supply within  $\pm 10\%$  of the rated voltage.
- The electrical protections (*fuses, etc.*) are the responsibility of the installer.
- Observe the recommended minimum distances between cables of different categories (**see table on page 10**).
- The following cables must comply with the maximum permissible lengths (**see table on page 10**), they must be shielded and must be inserted alone in metal conduits or pipes:
  - the load cell extension cables;
  - the signal amplifier cables;
  - the cables for connecting the serial ports;
  - the analog output cables.
- The cell or amplifier cables must have an independent input in the electrical panel. They must be connected (if possible) directly to the terminal block of the transmitter without passing through the conduit with other cables.
- Fit "RC" filters:
  - on the contactor coils;
  - on the solenoid valve coils;
  - on all devices that produce electrical interference.
- If condensation can occur inside the weight transmitter, it is advisable to keep the equipment powered at all times.
- Connections to load cells and any external device must be as short as possible.
- The cable ends (connectors, leads, terminals, etc.) must be installed correctly; the cable shielding must be kept intact until close to the connection point.
- If the transmitter is placed inside an electrical panel, a shielded cable must also be used for the power supply.

## RECOMMENDED DISTANCES AND CABLE CLASSIFICATION

	Category I	Category II	Category III	Category IV
<b>Distance</b>				
<b>Classification</b>	<p>Fieldbus, LAN network (PROFIBUS, Ethernet, Devicenet...).</p> <p>Shielded data cables (RS232...).</p> <p>Shielded cables for analog digital signals &lt; 25 V (sensors, load cells...).</p> <p>Low voltage power supply cables (&lt; 60 V).</p> <p>Coaxial cables.</p>	<p>DC supply cables with voltage &gt; 60 V and &lt; 400 V.</p> <p>AC supply cables with voltage &gt; 25 V and &lt; 400 V.</p>	<p>Power supply cables with voltage &gt; 400 V.</p> <p>Telephone cables.</p>	<p>Any cable subject to lightning danger.</p>

## MAXIMUM ALLOWED LENGTHS

Load cell	RS232	RS485	Analog output
<p>50 metres with 6 x 0.25 mm<sup>2</sup> cable;</p> <p>100 metres with 6 x 0.5 mm<sup>2</sup> cable.</p>	<p>15 m with baud rate up to 19200.</p>	<p>1200 m with shielded 2 x 24 AWG twisted pair with outer braid + aluminium strip.</p>	<p><b>CURRENT:</b>                      100 metres with 2 x 0.25 mm<sup>2</sup> cable;                      150 metres with 2 x 0.5 mm<sup>2</sup> cable;                      300 metres with 2 x 1 mm<sup>2</sup> cable.</p> <p><b>VOLTAGE:</b>                      50 metres with 2 x 0.25 mm<sup>2</sup> cable;                      75 metres with 2 x 0.5 mm<sup>2</sup> cable;                      150 metres with 2 x 1 mm<sup>2</sup> cable.</p>

# Earthing of the system

For correct earthing and optimal system operation, the transmitter, load cells, junction box, if any, and weighing structure must be earthed.

## TRANSMITTER

The earth connection must be made via the appropriate terminal. The cable cross-section must be less than 2.5 mm<sup>2</sup>.

## LOAD CELLS AND JUNCTION BOX

The connection must be made by connecting the earth cables to the earth bar (cables that must have a cross-section of at least 16 mm<sup>2</sup>); finally, connect the earth bar to the earth post with a cable having a cross-section of at least 50 mm<sup>2</sup>.

### EXAMPLES:

- If more load cells are connected to the transmitter through a junction box, the cable shield from the transmitter and the cell cable shields must be connected to the earth socket of the junction box (refer to the junction box manual) and the junction box must be earthed using a copper cable with a cross-section of not less than 16 mm<sup>2</sup>.
- If the load cell is connected directly to the transmitter (without using the junction box), the cell cable shields must be connected to the earthing point (or earth bar).
- If the weighing system involves large and/or outdoor structures (weighbridges, silos, etc.) and the distance between the junction box and the weight transmitter is greater than 10 m, connect the cell cable shields to the earth socket in the junction box.

## WEIGHING STRUCTURE

Earth the weighing structure and/or any unconnected structures (e.g. silos that release material onto the weighing structure) using cables with a cross-section of not less than 16 mm<sup>2</sup>.

Also connect the upper part with the lower part of each cell by means of a copper braid with a cross-section not less than 16 mm<sup>2</sup> (refer to the earthing examples on page 12 and page 13).

## SERIAL CABLES AND CONNECTED INSTRUMENTS

Connect the serial cable shield to the earthing point (or earth bar) inside the panel. To avoid any undesired effects, the earth reference of the connection cable, power supply and transmitter must be at the same potential.



### GENERAL NOTES:

- All earth cables must be of suitable length, so as to obtain an overall resistance of the earthing system of less than 1 Ω.
- If the weighing system involves large and/or outdoor structures (weighbridges, silos, etc.):
  - the earth connection must be made by connecting the earth cables to an earth bar and the earth bar to the earth post with a cable having a cross-section of not less than 50 mm<sup>2</sup>;
  - the thickness of the cables must be greater (50 mm<sup>2</sup> instead of 16 mm<sup>2</sup> and 100 mm<sup>2</sup> instead of 50 mm<sup>2</sup>), because the voltages at stake are greater (e.g. lightning);
  - the earth post must be placed at a distance of at least 10 m from the structure.
- If the load receiver is more than 10 m from the transmitter, we recommend using the SENSE line and load cells equipped with a (SENSE) compensation circuit.

**EXAMPLE OF EARTHING OF A WEIGHBRIDGE**

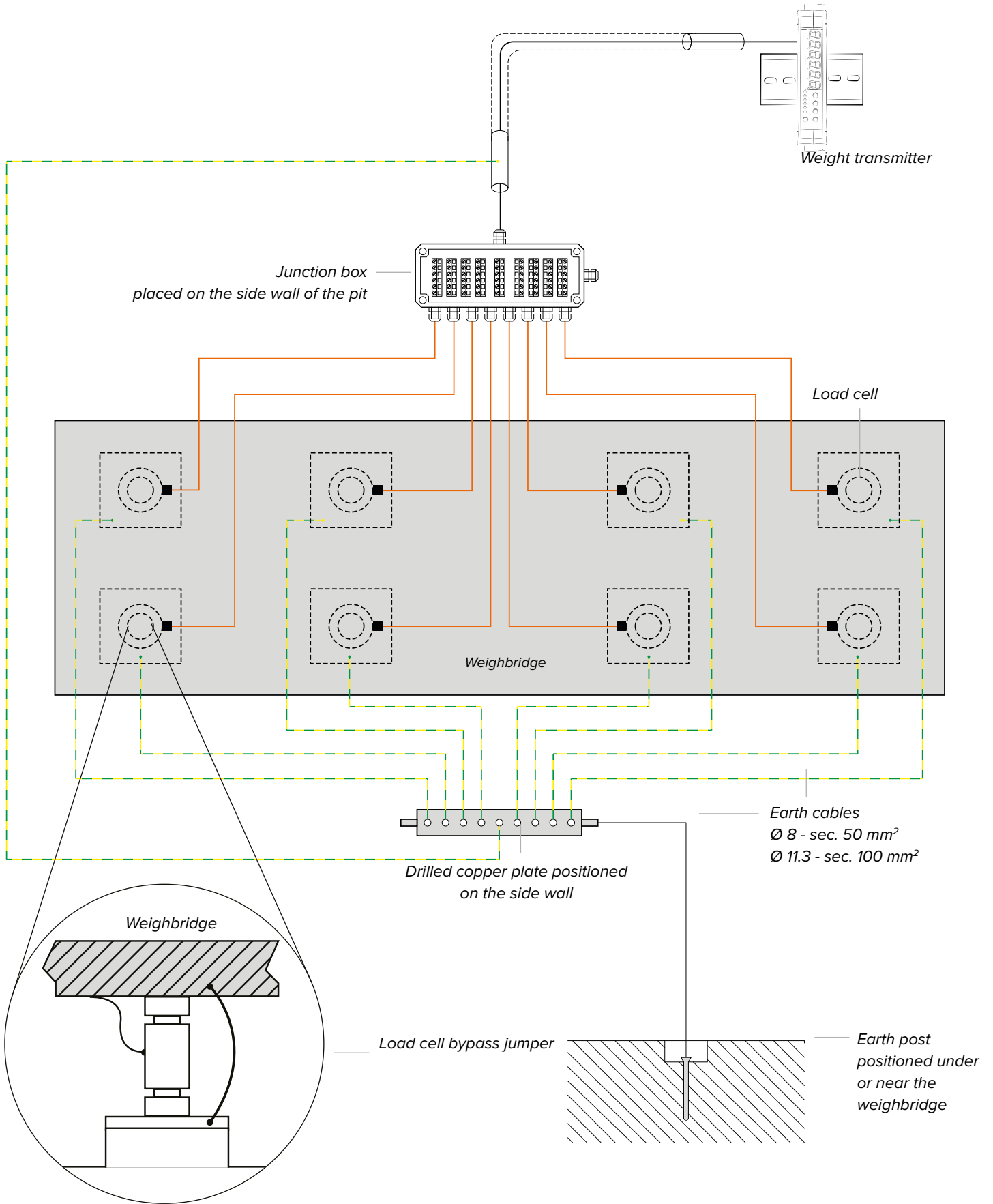

EXAMPLE OF EARTHING OF A SILO

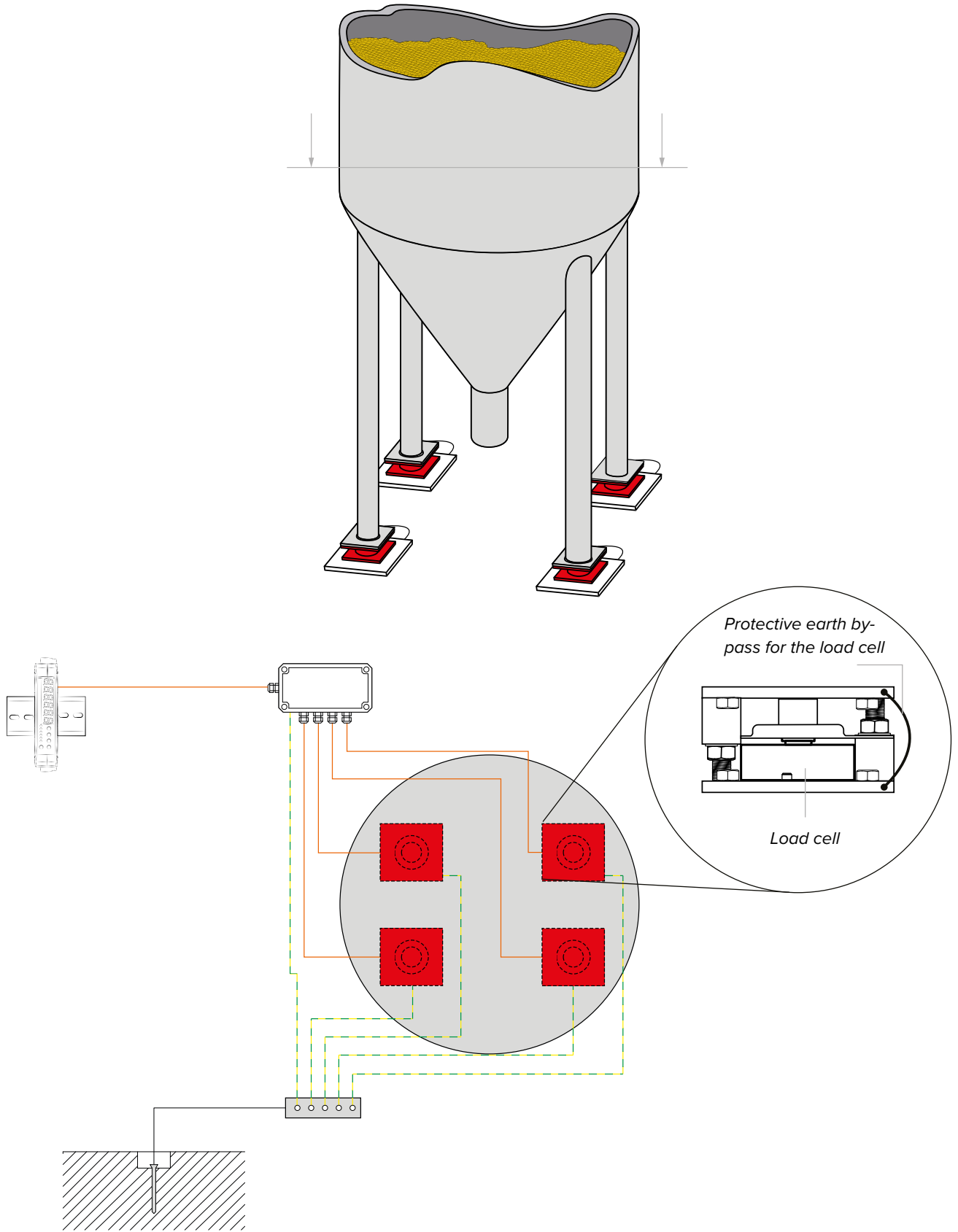

## Technical features

<b>POWER SUPPLY</b>	12 - 24 Vdc LPS or with class 2 power supply.
<b>MAXIMUM ABSORPTION</b> (without load cells)	DGT1SX: 1 W DGT1SX-AN: 2 W DGT1SX-PB: 2 W DGT1SX-ETHIP, DGT1SX-PRONET, DGT1SX-ETHCAT, DGT1SX-MODTCP: 4 W DGT1SX-COPEN, DGT1SX-DEVNET: 4 W
<b>OPERATING TEMPERATURE</b>	From -10°C to +40°C.
<b>DISPLAY DIVISIONS</b>	10000e, 2 x 3000e for legal weighing, expandable up to 800,000 for internal use (with a minimum cell signal of 1.6 mV/V).
<b>CONVERSION SPEED</b>	Up to 4800 conv. / sec.
<b>MINIMUM VOLTAGE PER DIVISION</b>	0.3 $\mu$ V ( <i>approved transmitter</i> ); 0.03 $\mu$ V ( <i>non-approved transmitter</i> ).
<b>COUNTING RESOLUTION</b>	1,500,000 points (with input signal 3 mV/V).
<b>DISPLAY</b>	6 digits, h 8 mm (0.3").
<b>SIGNALS</b>	6 status indicator LED lights.
<b>KEYPAD</b>	mechanical with 5 keys.
<b>TARE FUNCTION</b>	Subtraction possible over the entire range.
<b>LOAD CELL POWER SUPPLY</b>	5 Vdc, 250 mA.
<b>LOAD CELL CONNECTION</b>	6 wires or 4 wires.
<b>CONNECTABLE CELLS</b>	Up to 16 350 $\Omega$ cells.
<b>CASE</b>	Made of plastic (ABS), suitable for DIN rail mounting (EN 60715 - DIN43880) or wall mounting.
<b>SERIAL OUTPUTS</b>	1 half duplex RS485 bidirectional port on terminal (versions DGT1SX, DGT1SX-AN). 1 PROFIBUS port on DB9 connector (DGT1SX-PB* version); 2 ETHERNET ports (versions DGT1SX-ETHIP*, DGT1SX-MODTCP*, DGT1SX-ETHCAT*, DGT1SX-PRONET*); 1 CANOPEN port on 5-pole terminal (DGT1SX-CANOP* version); 1 DEVICENET port on 5-pole terminal (DGT1SX-DEVNET* version). 1 USB port (micro USB type B) $\rightarrow$ Virtual COM (Device).  <i>* Fieldbus models are not equipped with port 485.</i>
<b>OUTPUTS / INPUTS</b>	4 photomofset NO or NC outputs: max 60 Vdc 0.5 A max / 48 Vac 0.5A; 2 configurable inputs (bidirectional optocouplers): 12 - 48 Vdc; Input reading and output update time: 1 msec; 16-bit analog output (DGT1SX-AN version). Current: 0 - 20 mA / 4 - 20 mA. Voltage: 0 - 5 Vdc, 0 - 10 Vdc. The maximum applicable resistance on the current output is 300 $\Omega$ while the minimum applicable resistance on the voltage output is 1 k $\Omega$ .
<b>LOAD CELL SENSITIVITY</b>	Maximum sensitivity of the connectable load cells: 6 mV/V.
<b>FIELDBUS UPDATE RATES</b>	Up to 120 Hz.
<b>CERTIFICATIONS</b>	Indicated on the EC Declaration of Conformity of the product.

## Load cell installation

After carrying out the instructions for the platform or load receiver, the shielded cable from the cell must be properly connected to the terminal block of the transmitter (see section “Wiring diagrams”).

The transmitter has one channel for 6-wire connection to load cells (using the REFERENCE).

The REFERENCE allows you to compensate for any voltage drop on the section of cable connecting the transmitter to the load receiver. It is especially useful when the distance between the transmitter and the load receiver is more than 10 metres, or in high-resolution applications.

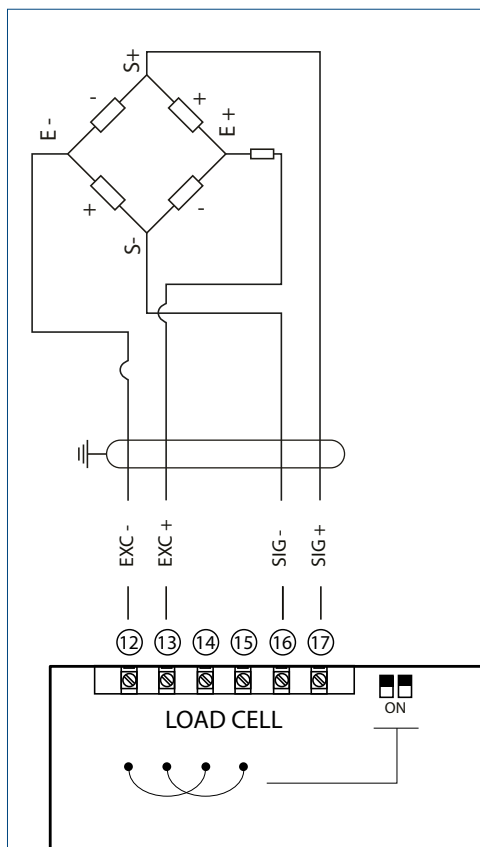

**4-WIRE CONNECTION**

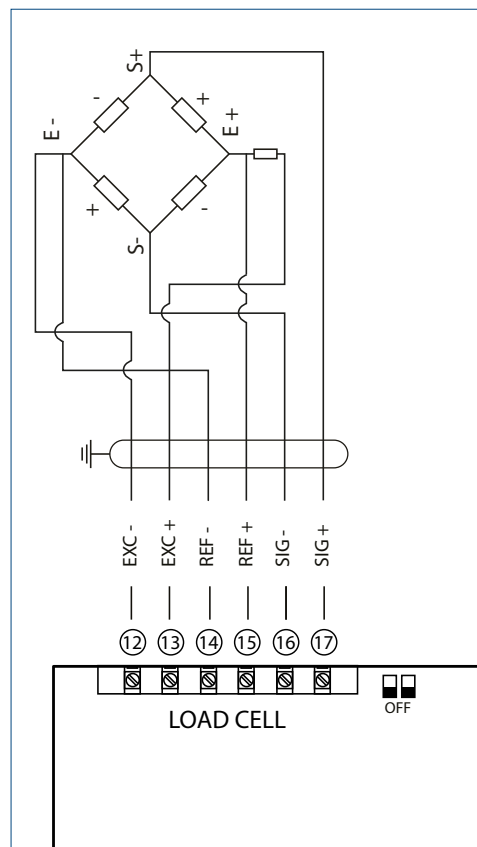

**4-WIRE CONNECTION**

## DGT1SX

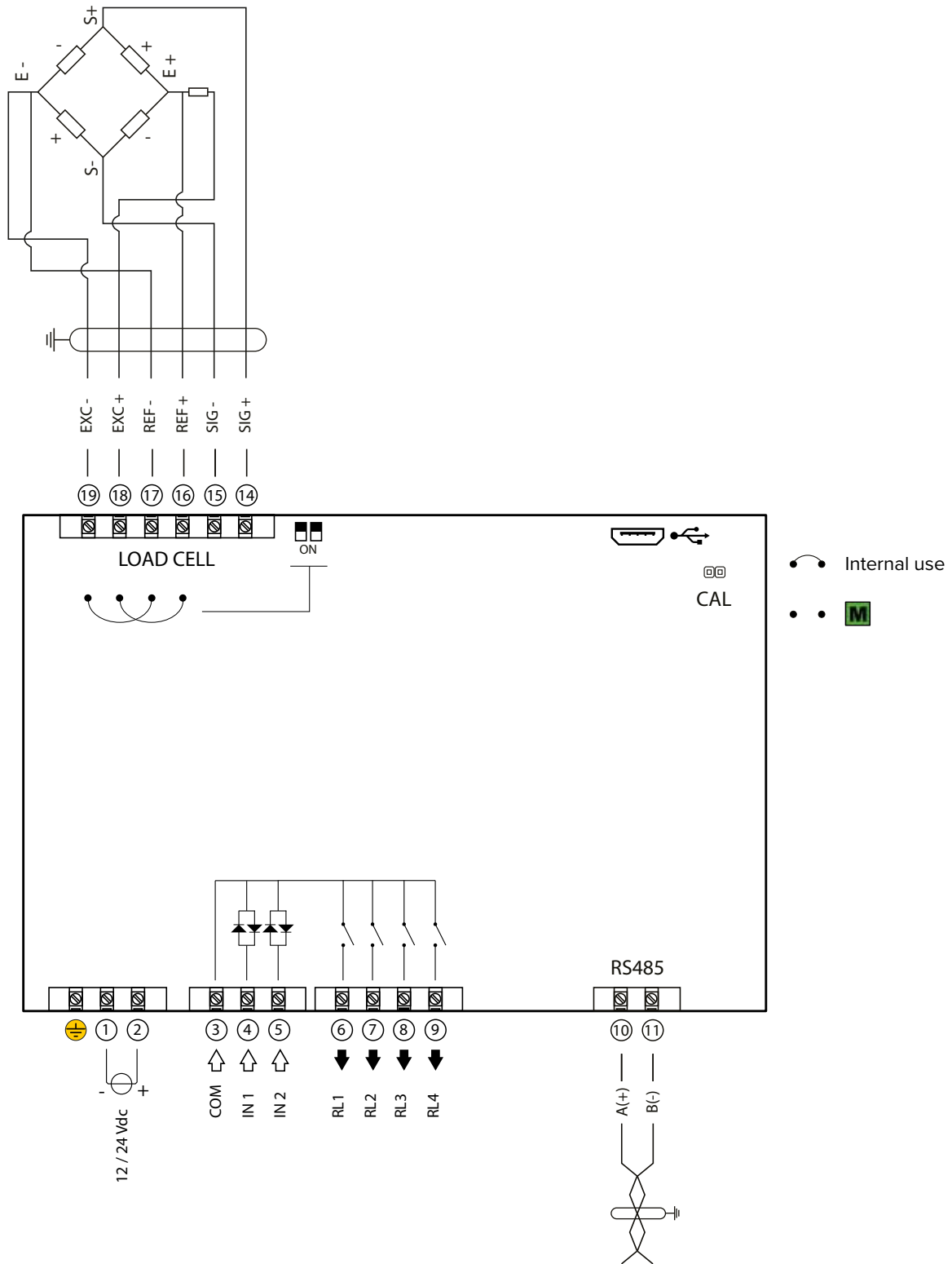



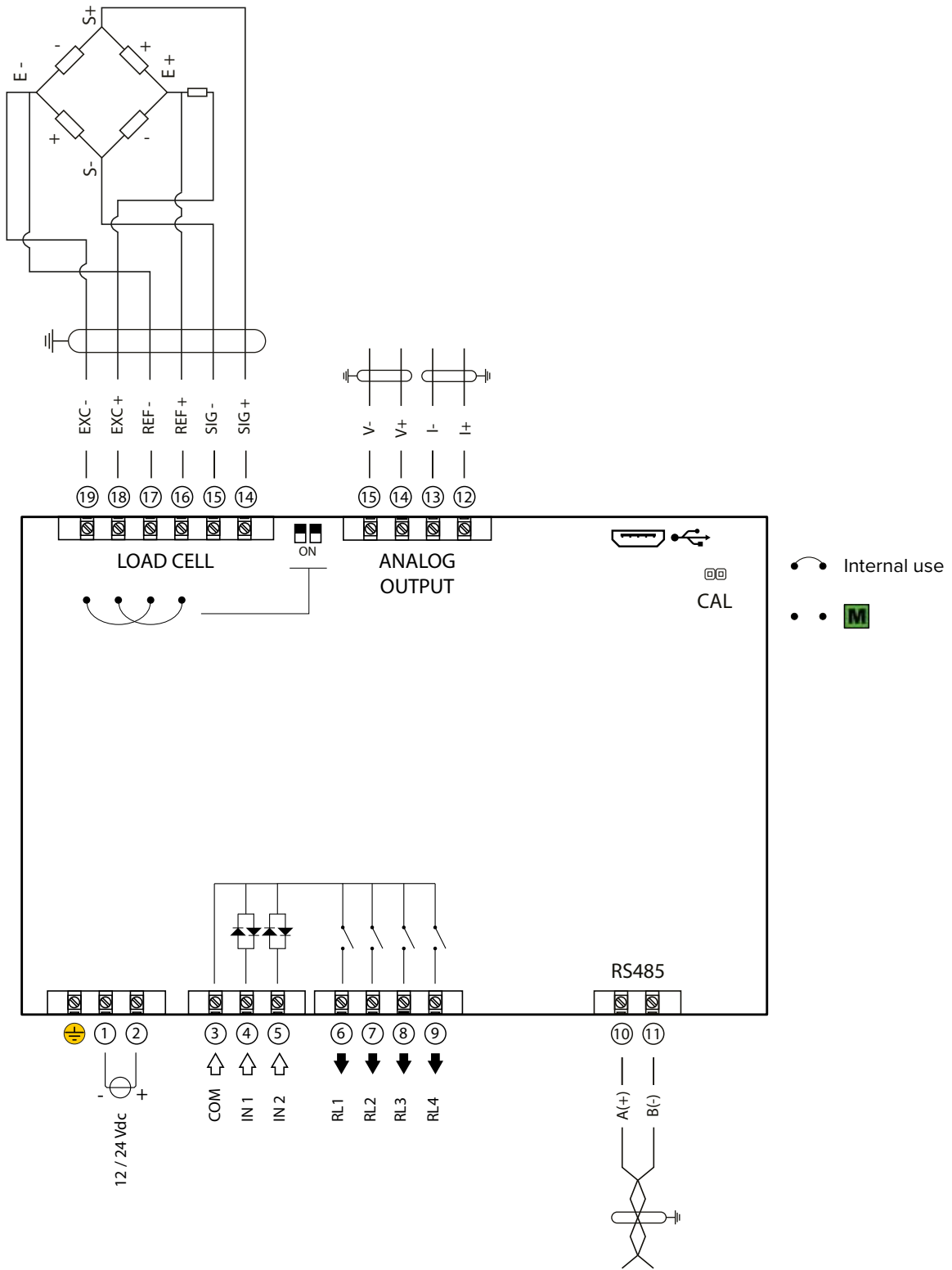

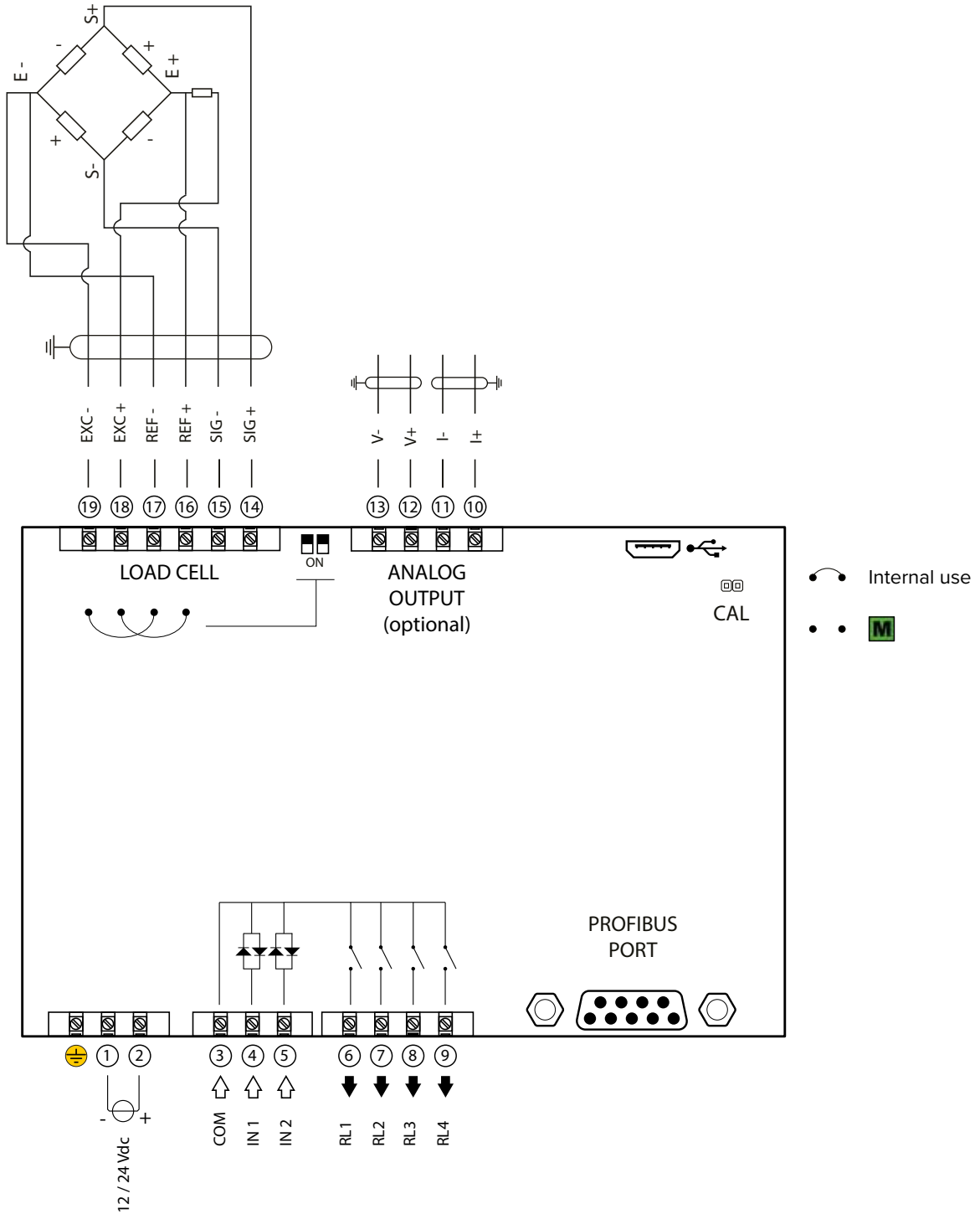

# DGT1SX-ETHIP, DGT1SX-ETHCAT, DGT1SX-PRONET, DGT1SX-MODTCP

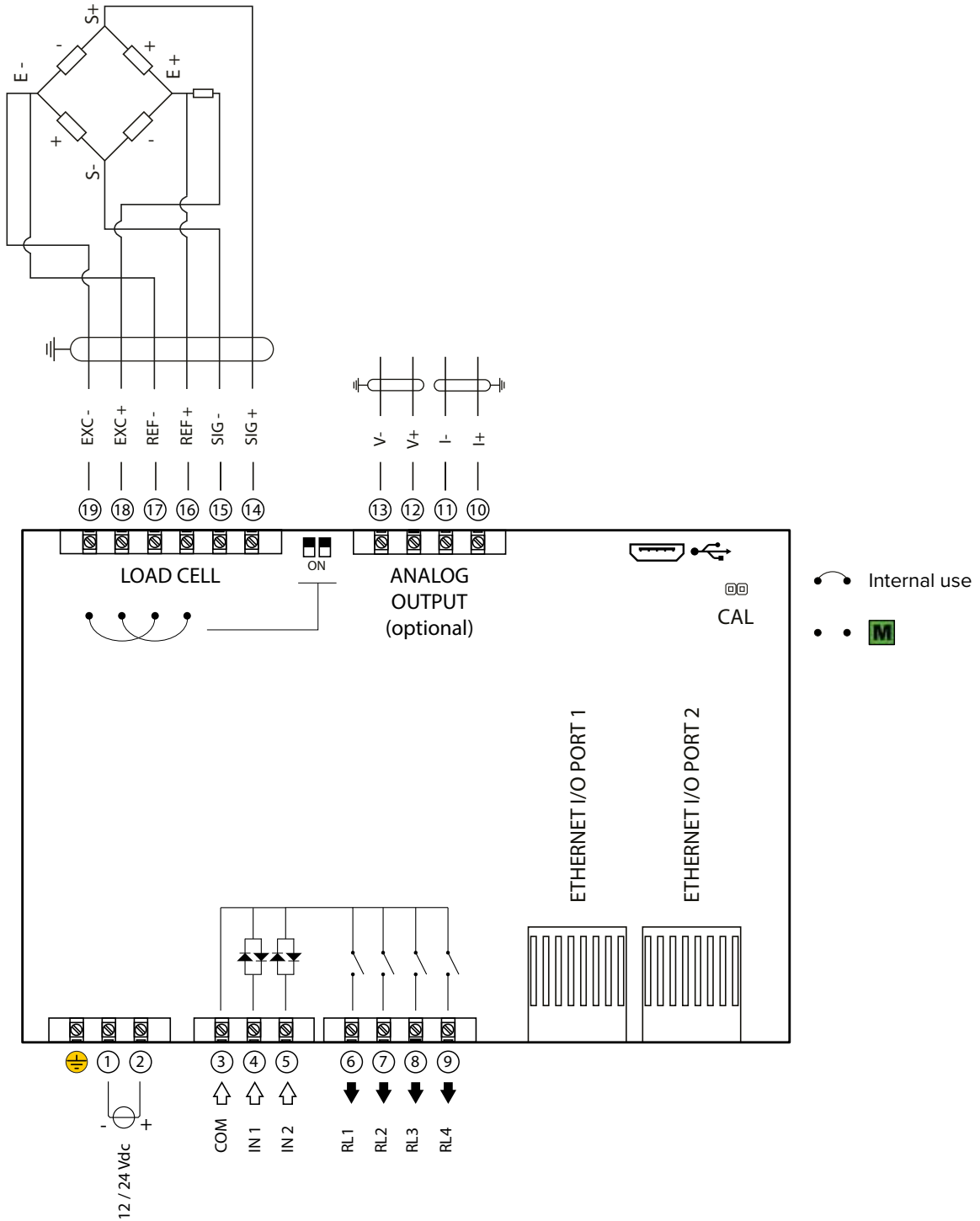

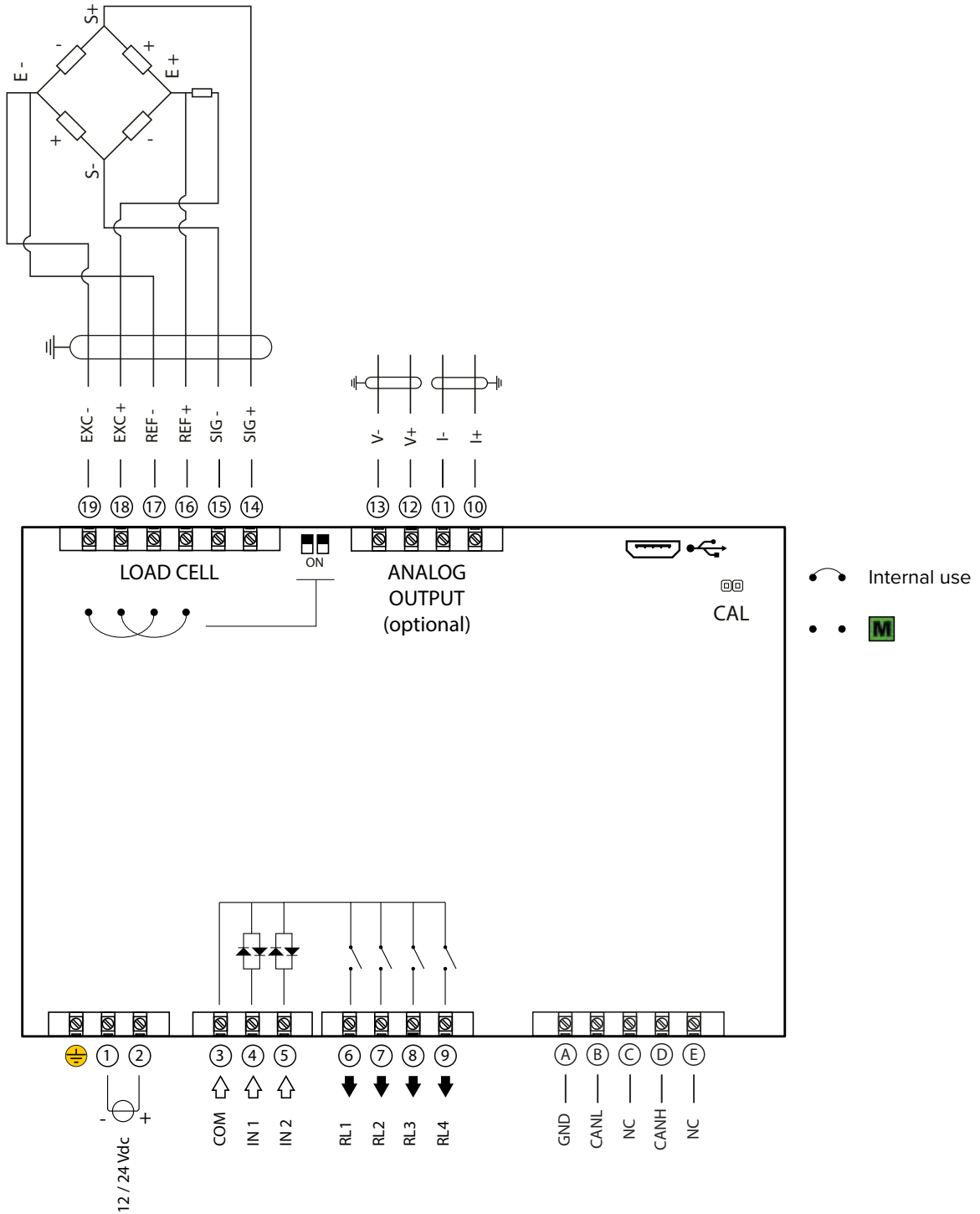

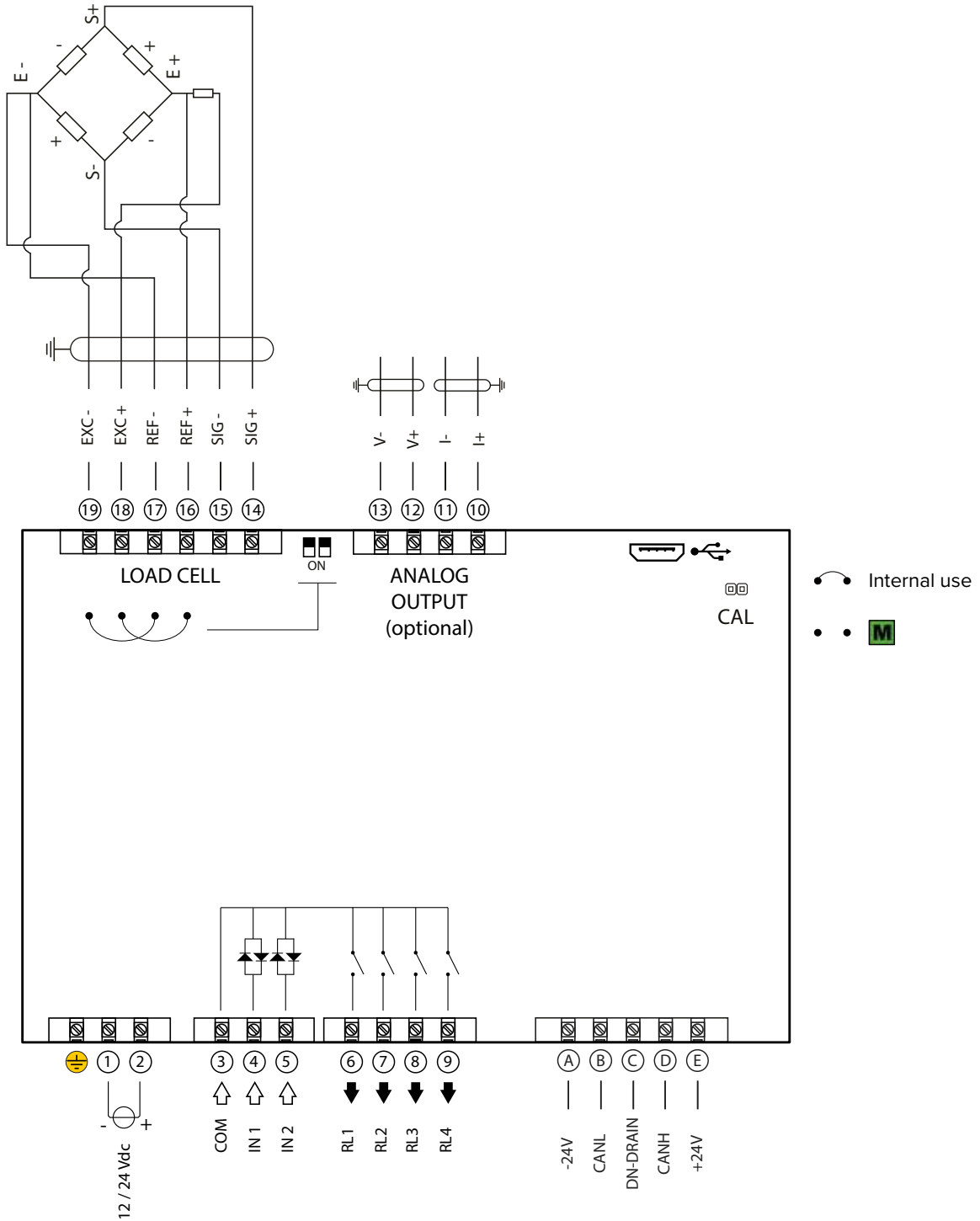

## Display and function of the keys

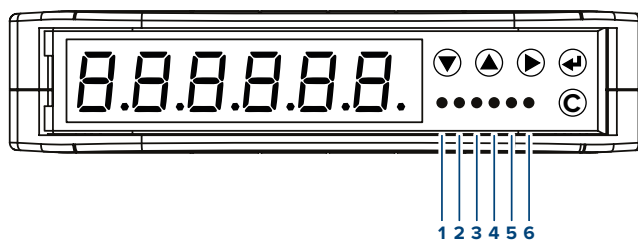

Symbol	Description
▼	Semi-automatic zeroing. Decreases the selected digit.
▲	Semi-automatic tare. Increases the selected digit.
▶	Activates the function. Selects the digit to be changed.
◀	Confirms a value. Prints / Transmits data.
C	Reboots the transmitter.

Number	Description
1	Gross weight on zero.
2	Unstable weight.
3	A tare is active.
4	A special function is active.
5	Output 1 is active.
6	Output 2 is active.

## Quick menu

The transmitter is equipped with a quick menu, through which you can program the main parameters of the scale. To enter the quick menu, follow the procedure below:

1. Reboot the transmitter.
2. Press the ▶ key when the display shows 888888.



For further information, refer to the transmitter Quick Start Guide.

# Advanced programming menu

The advanced menu contains all the transmitter configuration parameters for the most advanced adjustments.

## Access to the advanced menu and saving the changes

1. Reboot the transmitter.
2. Press the ▲ key when the display shows **BBBBBB**.



### HOW TO EXIT THE SETUP AND SAVE CHANGES

1. Press **C** several times, until the display shows "SAVE?".
2. Press **←** to save or **C** to exit without saving.

## Function of the keys in the menu

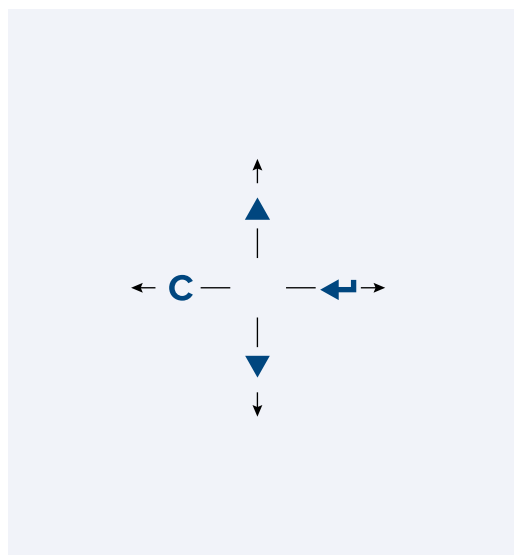

- ▲ Previous parameter.
- ▼ Next parameter.
- ← Access the parameter / confirm setting.
- C Exit a parameter (without saving).

### FUNCTION OF THE KEYS WHEN ENTERING NUMBERS

- ▲ Increases the selected digit.
- ▼ Decreases the selected digit.
- ▶ Selects the next digit.
- ← Confirms the value.
- C Resets the value.  
If pressed again, exits entering.



In the menu description on the following pages the ▼ symbol indicates repeated pressing of the ▼ key until the parameter indicated is reached.

#### LEGEND:

- ▼ Indicates repeated pressing of the ▼ key.
- 👁 Parameter visible only under certain conditions.
- 🔒 Parameter or menu subject to approval.
- ⚙ Default value of the parameter.



# Block diagram of the menu

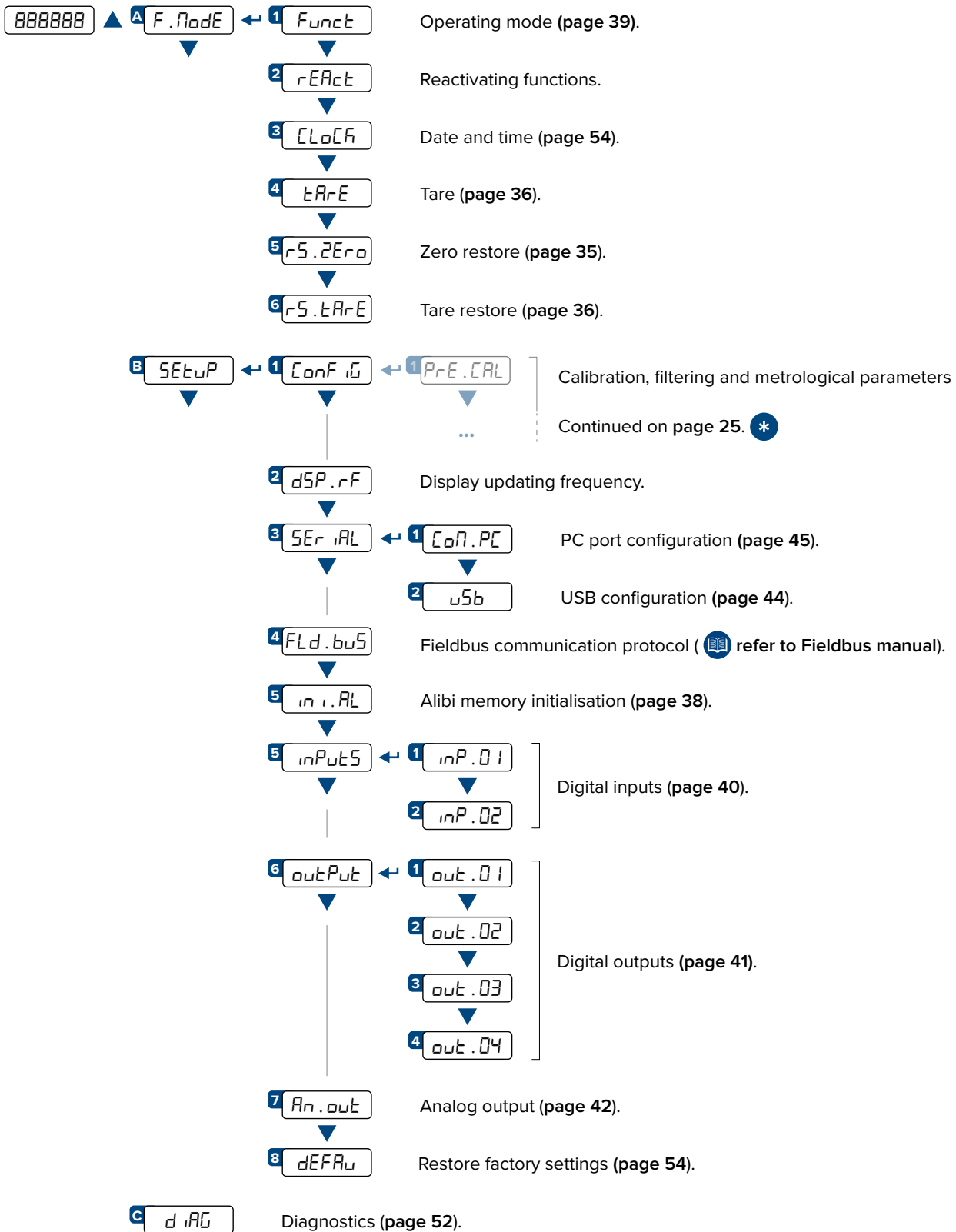

Complete menu on pages 24 - 25

### MENU ACCESS:

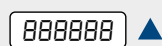

Press the ▲ key during the start-up procedure.

### SAVING THE PARAMETERS:

Press the C key several times, until the display shows SEtUP. Press the ← key to confirm.







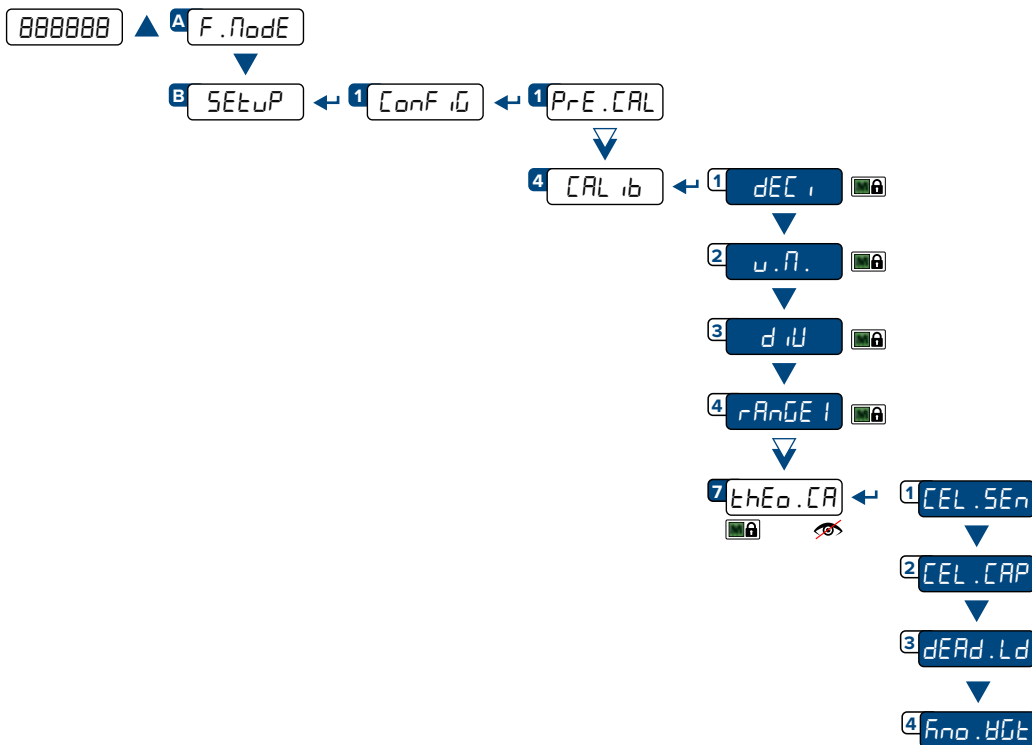

## CALIBRATION PROCEDURE:

### 1. Set the calibration parameters:

- $dEC i$  = Number of decimals.
- $u.n.$  = Unit of measurement (FG, G, t, Lb).
- $d iU$  = Minimum division.
- $rAnGE I$  = Maximum range.

### 2. Set the cell data:

- $SEn.CEL$  = Cell sensitivity (given by the average mV/V value of cells).
- $CEL.CAP$  = Total capacity of the cells (given by the sum of the capacities of each cell).

### 3. Enter the weight value of the structure in the $dEAd.Ld$ parameter. If you do not know this value, enter "0".

### 4. If the structure contains a quantity of material whose weight value is known (e.g. full silo), enter this value in the $fno.BUt$ parameter.

### 5. Application of theoretical calibration:

Press the **C** key to exit the calibration menu. The display shows  $th.CALP$ . Press the **←** key to confirm the use of the theoretical calibration, or the **C** key to cancel.



Complete menu  
on pages 24 - 25

#### MENU ACCESS:



Press the **▲** key during the start-up procedure.

#### SAVING THE PARAMETERS:

Press the **C** key several times, until the display shows  $SAUEP$ . Press the **←** key to confirm.



# Calibration with sample weights

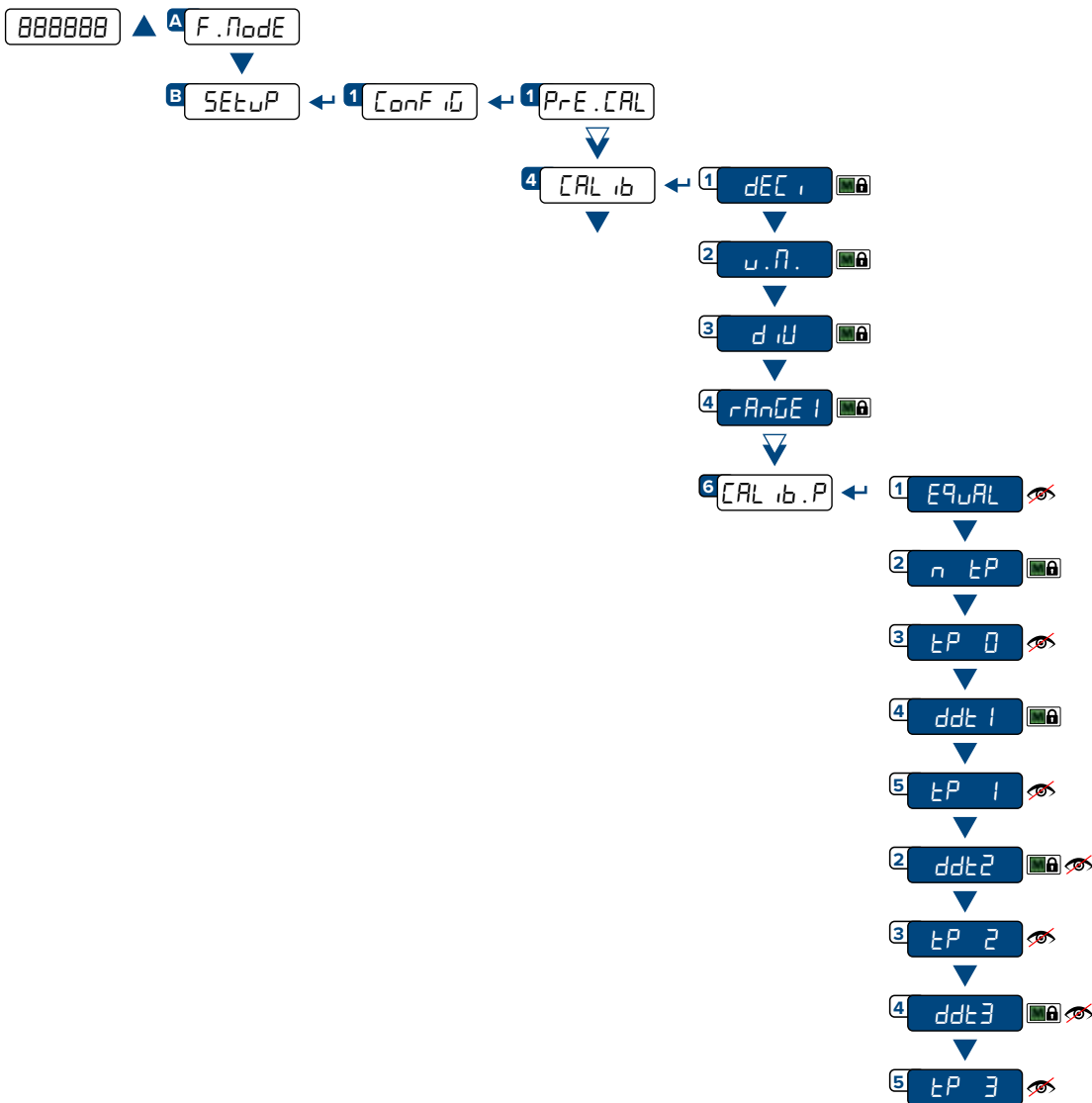

## CALIBRATION PROCEDURE:

### 1. Set the calibration parameters:

- $dEC i$  = Number of decimals.
- $u.n.$  = Unit of measurement (FG, G, t, Lb).
- $d.iU$  = Minimum division.
- $rAnGE 1$  = Maximum range.

### 2. Acquire the calibration points (continued on next page)

#### LEGEND:

- Indicates repeated pressing of the  $\nabla$  key.
- Parameter visible only under certain conditions.
- Parameter or menu subject to approval.
- Default value of the parameter.



3. Acquire the calibration points:

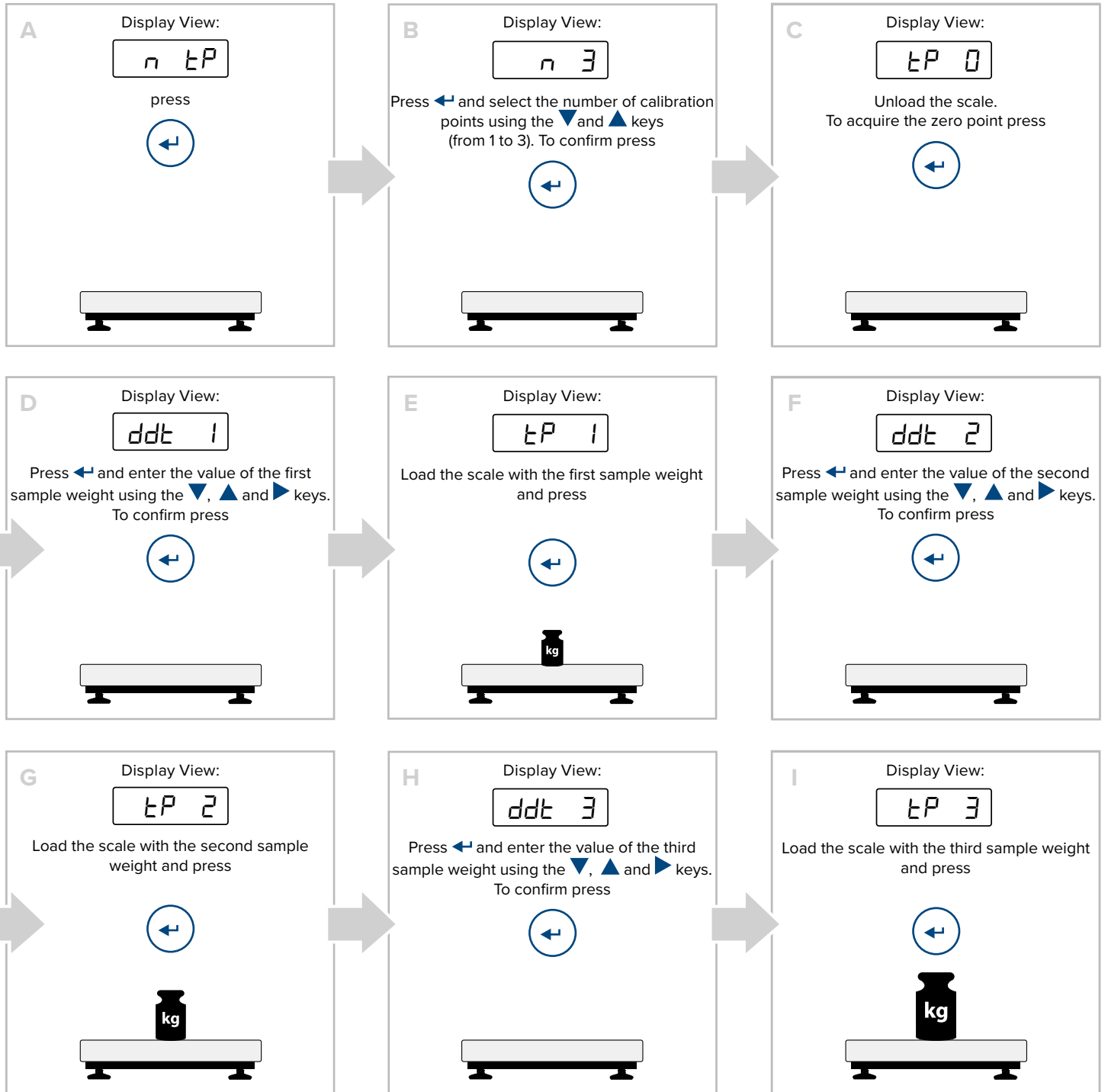

For successful calibration, the value of the largest sample weight must be at least 50% of the capacity.



Complete menu on pages 24 - 25

**MENU ACCESS:**



Press the key during the start-up procedure.

**SAVING THE PARAMETERS:**

Press the key several times, until the display shows SAUEP. Press the key to confirm.

# Manual calibration

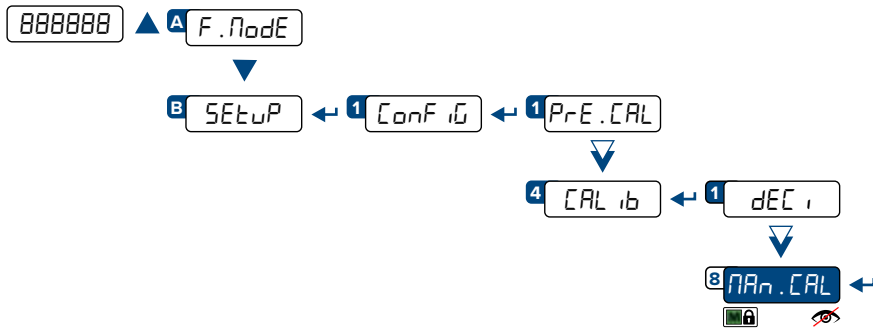

If you know the number of ADC converter points for a known weight (for example if you want to copy the calibration from one transmitter to another) the calibration points can be entered manually:

1. The display shows  $n_{ad} . P_{nt}$ , and then the last calibration point.
2. Using the ▲ and ▼ keys, select the calibration point you want to enter / change (from 0 to 9). Press the ← key to confirm.
3. The display shows  $WE iGht$ , use the ▲, ▼ and ▶ keys to enter the weight value. Press the ← key to confirm.
4. The display shows  $P_{o} intS$ , use the ▲, ▼ and ▶ keys to enter the converter points value. Press the ← key to confirm.



## Quick zero calibration (pre-tare reset)

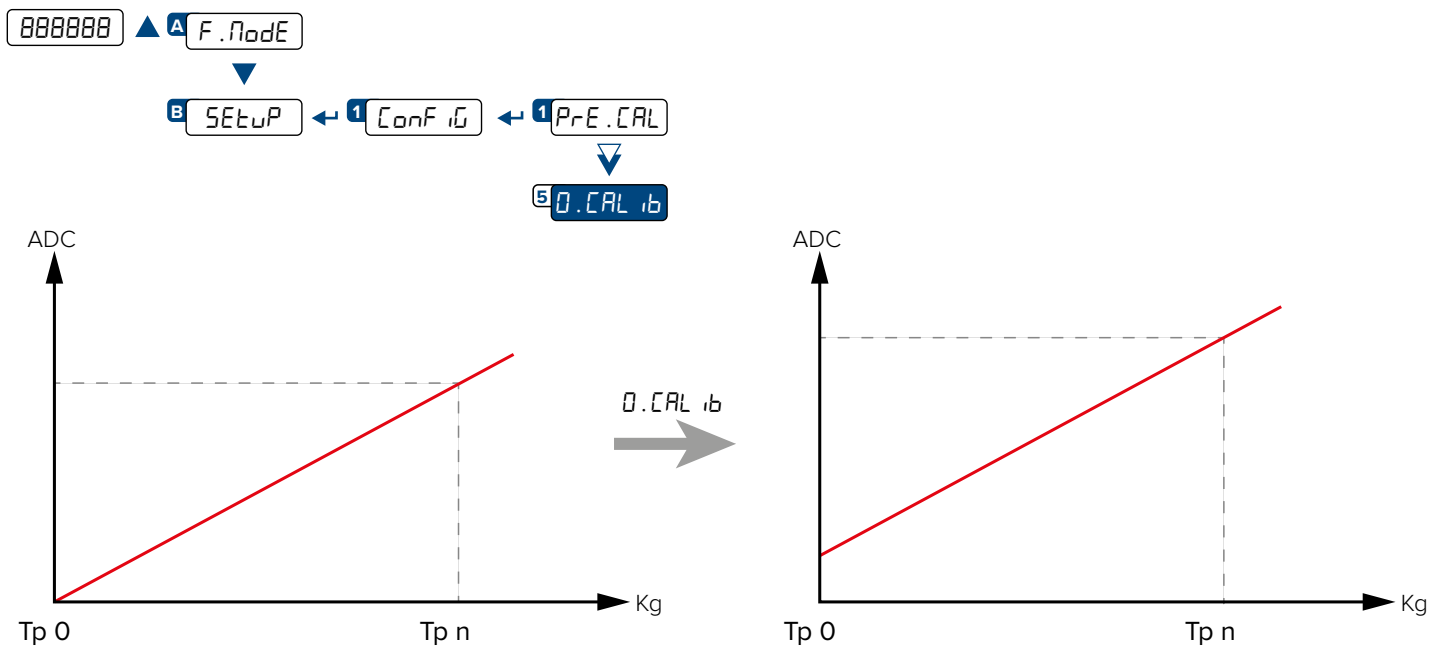

### LEGEND:

-  Indicates repeated pressing of the ▼ key.
-  Parameter visible only under certain conditions.
-  Parameter or menu subject to approval.
-  Default value of the parameter.



# ADC converter precalibration

888888 ▲ A F.NoDE

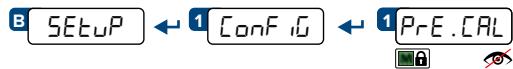

For manufacturer use only

## Filter and stability

### Filter adjustment

888888 ▲ A F.NoDE

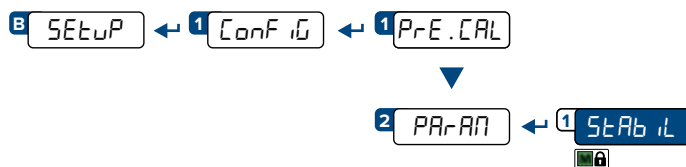

Filter	Updating frequency (Hz)	Response time (ms)	Use
F 1	5	5000	High resolution or Oscillating loads
F 2	10	2500	
F 3	20	1000	Simple weighing
F 4	40	450	Dosing
F 5	80	300	
F 6	160	150	
F 7	325	50	High-speed weight transmission
F 8	650	35	
F 9	1300	20	
F 10	2600	10	
F 11	4800	5	



In the case of an approved transmitter, it is possible to select only filter F 3.

The filter affects the speed of the PC port only if ALL.PAR mode has been selected.



Complete menu on pages 24 - 25

#### MENU ACCESS:

888888 ▲

Press the ▲ key during the start-up procedure.

#### SAVING THE PARAMETERS:

Press the C key several times, until the display shows SETUP. Press the ← key to confirm.



## Anti-peak filter

The transmitter has an additional filter for the elimination of sudden weight peaks (e.g. shocks or falling material).

The following parameters, opportunely configured, allow you to eliminate the peak by blocking the weight for its entire duration.

The weight is blocked if it remains within the number of divisions set in  $PF.LF.dU$  for the time set in  $PF.LF.tN$  and is subsequently unblocked if the weight deviates from the blocking value for a number of divisions greater than  $PF.d.U$  (or  $PF.bn.dU$ ) or if the time set in  $PF.t.nE$  has elapsed.

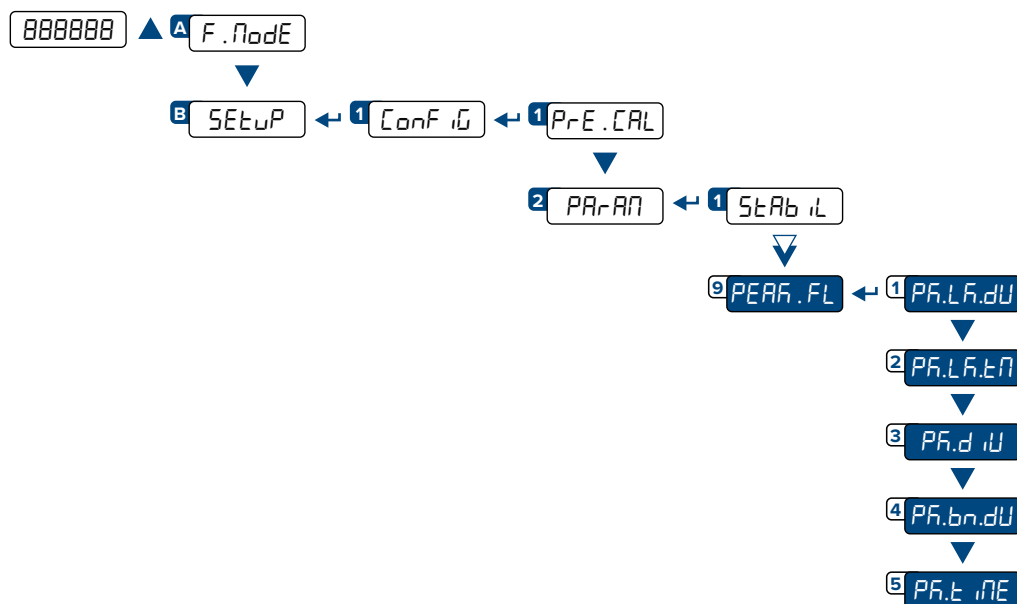

## Stability detection divisions

It is possible to decide that tare and zero functions (from keypad or serial command / PLC) are performed only if the weight is stable.

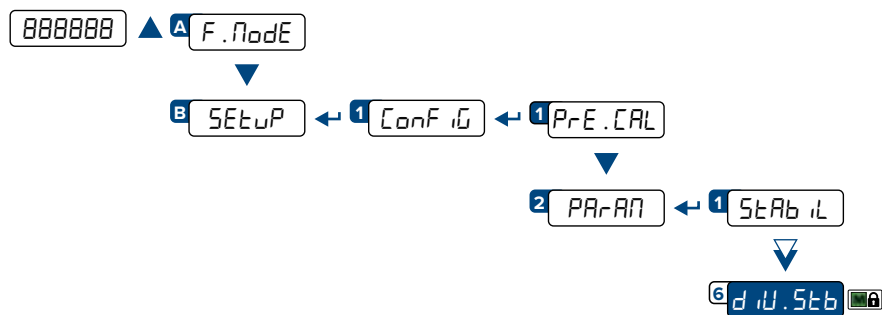

The value 0 disables the stability control.

By entering a value other than 0, you enable stability control.

Enter the number of deviation divisions beyond which the transmitter detects instability.

From 0 to 99.

= 02.

= 02.

### LEGEND:

Indicates repeated pressing of the key.

Parameter visible only under certain conditions.

Parameter or menu subject to approval.

Default value of the parameter.

## Stability detection time

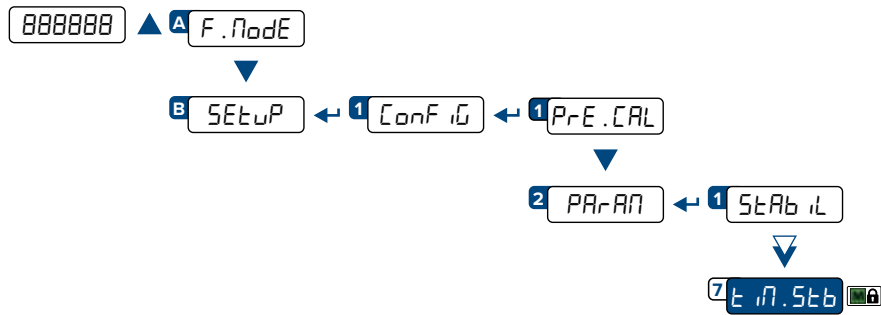

If the weight remains within the number of divisions set in *d iL.Stb* for the time set in this parameter, the weight is stable.

Enter the value in ms. In case of approved transmitter, the value is fixed at 500 ms.

from 10 to 10000.

500.

⚙️ = 500.



## Additional filter for stability detection

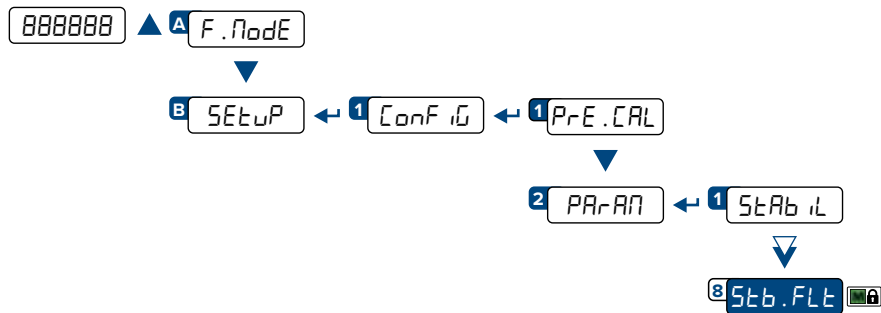

Additional filter that locks the weight if it oscillates around a value for a maximum of 10 divisions. The weight is unlocked if the value increases/decreases for a time value greater than the time set in this parameter.

The value 0 disables the filter.

from 0 to 2000.

0.

⚙️ = 0.



Complete menu  
on pages 24 - 25

### MENU ACCESS:

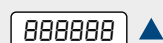

Press the ▲ key during the start-up procedure.

### SAVING THE PARAMETERS:

Press the C key several times, until the display shows *SAUEP*. Press the ← key to confirm.





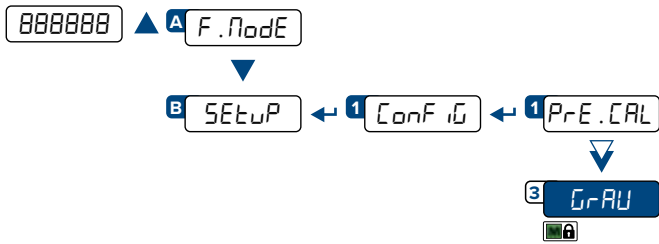

From 9.7500 l to 9.84999.  
 ⚙️ = 9.80390.

This parameter allows you to correct the gravity acceleration value.  
 Before calibration, set the value of the calibration zone.  
 Next, set this value to the value of the zone of use.  
 Any difference between the two values will be automatically compensated.

**i** In the case of an approved transmitter, the value is read-only.

**EXAMPLE:**



Calibration zone  
 Italy  
 g = 9.80390



Zone of use  
 Brazil  
 g = 9.77623

1. Before calibration, in the GrAU parameter enter the value 9.80390.
2. Calibrate the transmitter.
3. Before using the transmitter, in the GrAU parameter enter the value 9.77623.

**LEGEND:**

- Indicates repeated pressing of the key.
- Parameter visible only under certain conditions.
- Parameter or menu subject to approval.
- Default value of the parameter.

# Reset functions and parameters

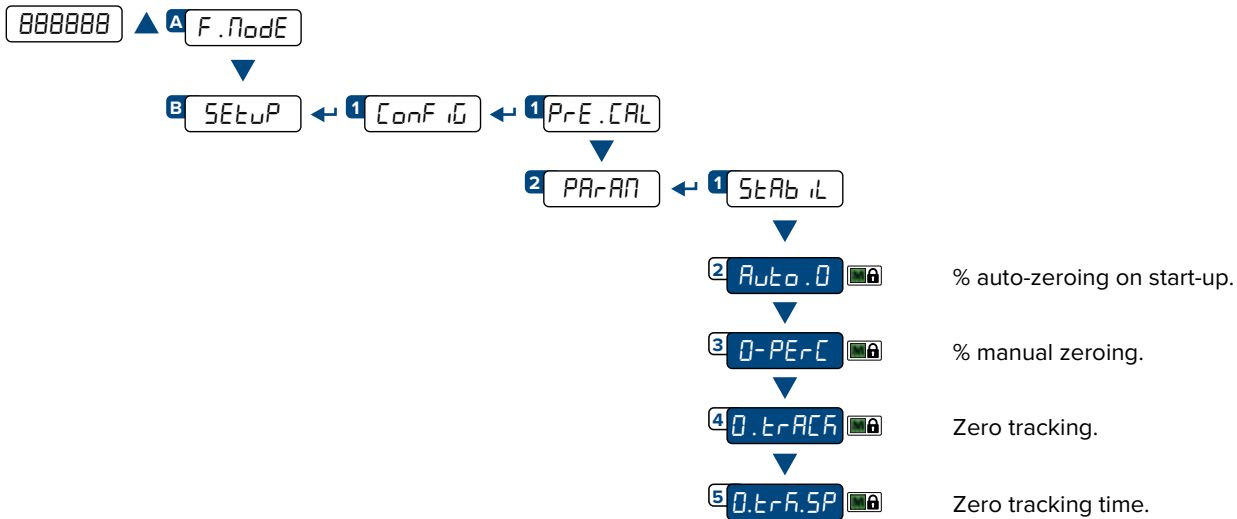

## Auto-zeroing on start-up

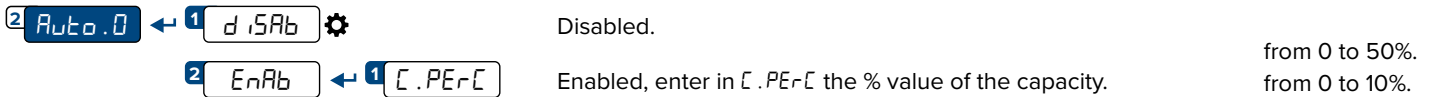

## Maximum percentage of manual zeroing

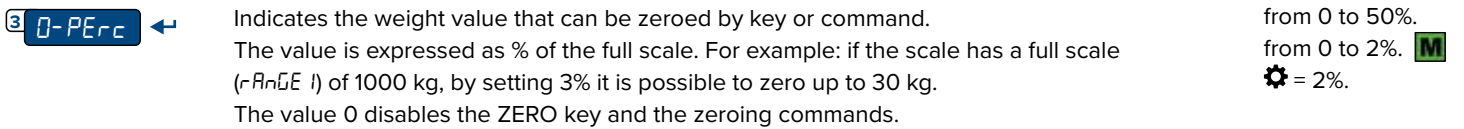

Complete menu on pages 24 - 25

### MENU ACCESS:



Press the ▲ key during the start-up procedure.

### SAVING THE PARAMETERS:

Press the C key several times, until the display shows SEtUP. Press the ← key to confirm.



## Zero tracking

This menu allows to set zero tracking, i.e. the compensation parameter of the thermal drift of the scale; the set value corresponds to the number of divisions that is reset to zero in the fixed time of 1 second.

<b>4</b>	<b>0.trACK</b> ←	<b>1</b>	tr 10	10 divisions.
		<b>2</b>	tr 8	8 divisions.
		<b>3</b>	tr 6	6 divisions.
		<b>4</b>	tr 4	4 divisions.
		<b>5</b>	tr 2	2 divisions.
		<b>6</b>	tr 1	1 division.
	<b>M</b>	<b>7</b>	tr 1/2	1/2 division.
	<b>M</b>	<b>8</b>	tr 1/4	1/4 division.
	<b>M</b>	<b>9</b>	tr no	Tracking disabled.

## Zero tracking time

<b>5</b>	<b>0.trH.SP</b> ←	Once stability is reached, the transmitter waits for the time set in this parameter before bringing the weight back to zero (if it is within the divisions set in <b>0.trACK</b> ).	from 100 to 5000. 1000. = 1000.
----------	-------------------	---	---------------------------------------

## Restoring zero

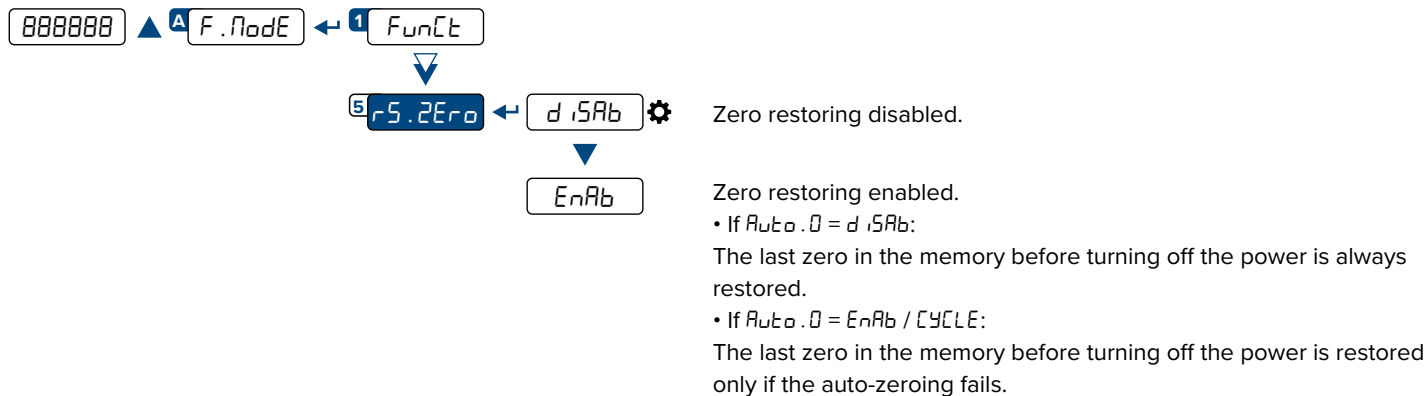

## Semi-automatic zeroing

By pressing the ▼ key, or sending the zero command, the transmitter zeroes the gross weight on the scale. For a moment the display shows “zEr0” and then it shows 0 (gross weight).

The semi-automatic zeroing cannot be performed if:

- The weight on the scale is greater than the zero capacity (**0.PErC**).
- The weight is unstable.

### LEGEND:

- Indicates repeated pressing of the ▼ key.
- Parameter visible only under certain conditions.
- Parameter or menu subject to approval.
- Default value of the parameter.



## Tare mode

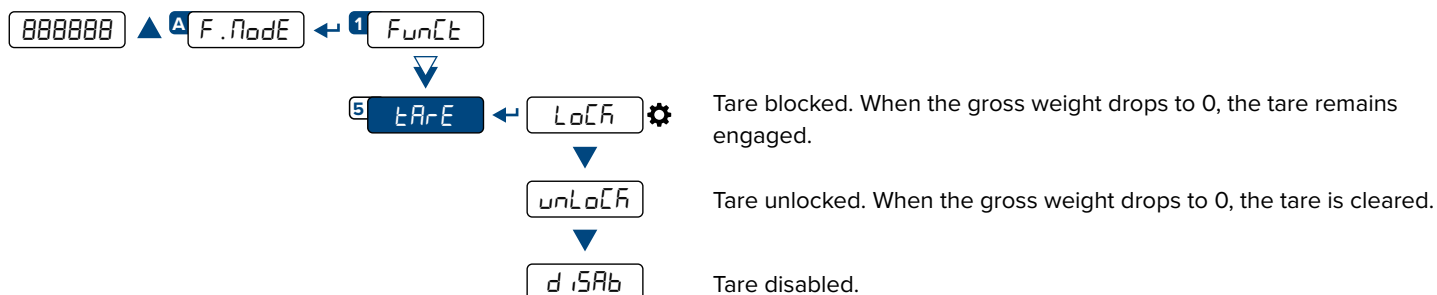

## Semi-automatic tare

By pressing the ▲ key, or sending the tare command, the transmitter sets as tare the weight on the scale. For a moment the display shows “tArE” and then it shows 0 (net weight). The **3** light indicates that the net weight is shown on the display.

The semi-automatic tare cannot be performed if:

- The weight is less than one division.
- The weight is overloaded.

## Predetermined tare

By holding down the ▲ key, or by means of the predetermined tare command, it is possible to enter a tare value manually. For a moment the display shows “-tN-” and shows the tare present (or 0 if no tare is present). Enter the tare value and press ← to confirm.

## Clearing the tare

The tare can be cleared in different ways:

- By unloading the scale and performing a semi-automatic tare.
- By entering a predetermined tare value of 0.
- If the weight is negative, pressing the ▼ key.

## Restoring the tare

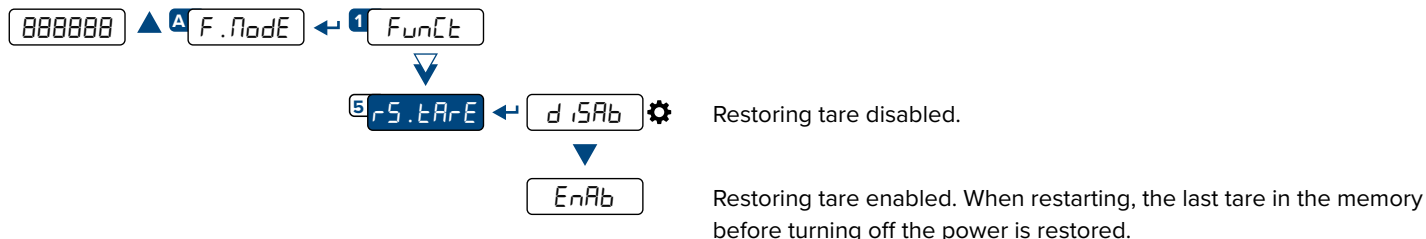

Complete menu  
on pages 24 - 25

### MENU ACCESS:

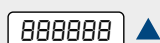

Press the ▲ key during the start-up procedure.

### SAVING THE PARAMETERS:

Press the **C** key several times, until the display shows SAUEP. Press the ← key to confirm.



The alibi memory allows you to store the weight values transmitted to the computer for further processing and/or data integration. The stored values can then be retrieved from the PC port or directly on the display of the transmitter for later checking.

## Enabling the alibi memory

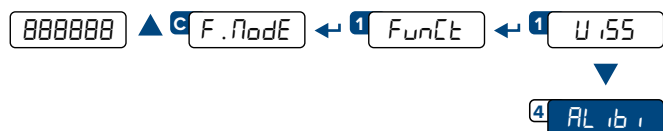

## Saving a weighing operation in the alibi memory

A weighing operation is stored after receiving the **PID** serial command (see “Serial commands” page 57) or after pressing the **←** key. The transmitter transmits on the PC port the gross weight, the tare and an ID code that uniquely identifies the weighing. The ID has the following format:

- rewrite number: 5-digit number (from 00000 to 00255) indicating the number of complete rewrites;
- weighing number: 6-digit number (from 000000 to 131072) indicating the weighing number in the current rewrite.

Each time it is saved, the weighing number is increased by 1; when it reaches the value 131072, it starts again from 000000 and the rewrite number is increased by 1.

### Example

If the weighing that has been saved is as follows:

**PIDST,1, 1.000kg, 1.000kg,00126-131072**

The next one will be:





**PIDST,1, 1.000kg, 1.000kg,00127-000000**

A weighing operation can only be saved if the weight  $\geq 0$ , stable and valid (not underloaded or overloaded). To store the weighing operation by key, the function must be active (see “Reactivating printing” on page 53). In addition, if the transmitter is approved, the weight must exceed 20 divisions.

If these conditions are not met:

- the response to the PID command will have “NO” instead of the ID (**PIDST,1, 1.000kg, 1.000kg,NO**);
- there is no transmission when the **←** key is pressed.

### LEGEND:

-  Indicates repeated pressing of the **▼** key.
-  Parameter visible only under certain conditions.
-  Parameter or menu subject to approval.
-  Default value of the parameter.

# Reading the alibi memory

## FROM THE TRANSMITTER (MANUAL)

By pressing the **▶** key you can read a saved weight:

you will be asked to enter the rewrite number "rEB . id" (from 0 to 255) and the ID number " id" (from 0 to 131072).

The weighing data are shown. Use the **▼** and **▲** keys to scroll through the following information:

- "Ch . X", where X indicates the scale number.
- "un YY", where YY indicates the unit of measurement (Fg, G, E or Lb).
- "Gross", followed by the gross weight.
- "TARE / tAREPL", followed by the tare value.

Press the **C** key to return to weighing.

The weighing of an ID can only be verified if:

- it has a rewrite number equal to the current alibi memory number and a weighing number ≤ the last value received with the PID command;
- it has a rewrite number ≥ 0, but 1 less than the current alibi memory value, and a weighing number greater than the last value received with the PID command.

## FROM PC

To read a weighing operation from a PC, see the serial command "READING A WEIGHING OPERATION IN THE ALIBI MEMORY" on page 57.

## FROM PLC

To read a weighing operation from a PLC, refer to the Modbus and Fieldbus protocol manuals.

**i** If the alibi memory is empty, when the **▶** key is pressed the display shows "EMPTY" for one second and returns to weighing mode. If an invalid ID is entered, the display shows "no id" and returns to weighing mode.

# Initialising the alibi memory

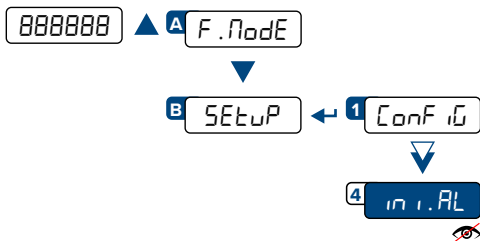

Not visible if the transmitter is approved.

**i** This operation deletes all saved weighing operations; it is not possible to delete a weighing operation individually.



Complete menu on pages 24 - 25

### MENU ACCESS:

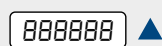

Press the **▲** key during the start-up procedure.

### SAVING THE PARAMETERS:

Press the **C** key several times, until the display shows **SAVEP**. Press the **←** key to confirm.



## Use functions

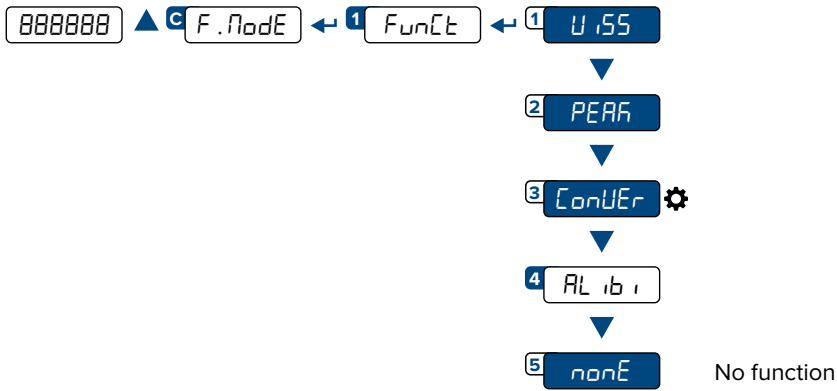

## High resolution

**U,SS** Weight display in high resolution (x10). Press the **▶** key to activate or deactivate the function. When the weight is displayed in high resolution, the **4** light is lit. In the case of an approved transmitter, the high-resolution weight display is automatically deactivated after 5 seconds.

## Peak detection

**PERF** Detection of the maximum weight value during a time interval. Press the **▶** key to activate the function. The display shows “-PERF-” every 5 sec and the transmitter shows the maximum weight reached since the function was activated. To deactivate the function press the **▶** again, the display shows “PERF0F” for a moment and shows the instantaneous weight again. By holding down the **◀** key it is possible to select in the **P.L.T.iT** parameter the minimum time of the pulse duration, expressed in hundredths of a second. The lower this value, the higher the peak function sensitivity.

## Converting units of measurement

**CONVr** Converting the scale unit of measurement using a free conversion factor. Press the **▶** key to convert the weight to pounds. By holding down the **▶** key, you can enter a free conversion factor, which will be multiplied by the weight. **Example:** to make the display show the cubic meters of water on the scale, enter the value 997 as the conversion factor. The **▶** key can be used to switch from the main unit of measurement to the secondary unit at any time. When the secondary unit of measurement is displayed, the **4** light is lit.

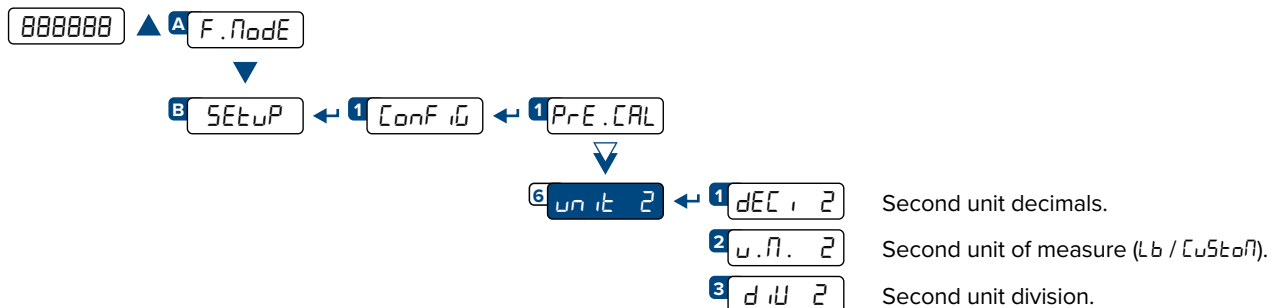

## Alibi memory

**ALibi** (See section “Alibi memory” page 43).

### LEGEND:

-  Indicates repeated pressing of the **▼** key.
-  Parameter visible only under certain conditions.
-  Parameter or menu subject to approval.
-  Default value of the parameter.



# Input configuration

The indicator has 2 configurable inputs (bidirectional optocouplers).

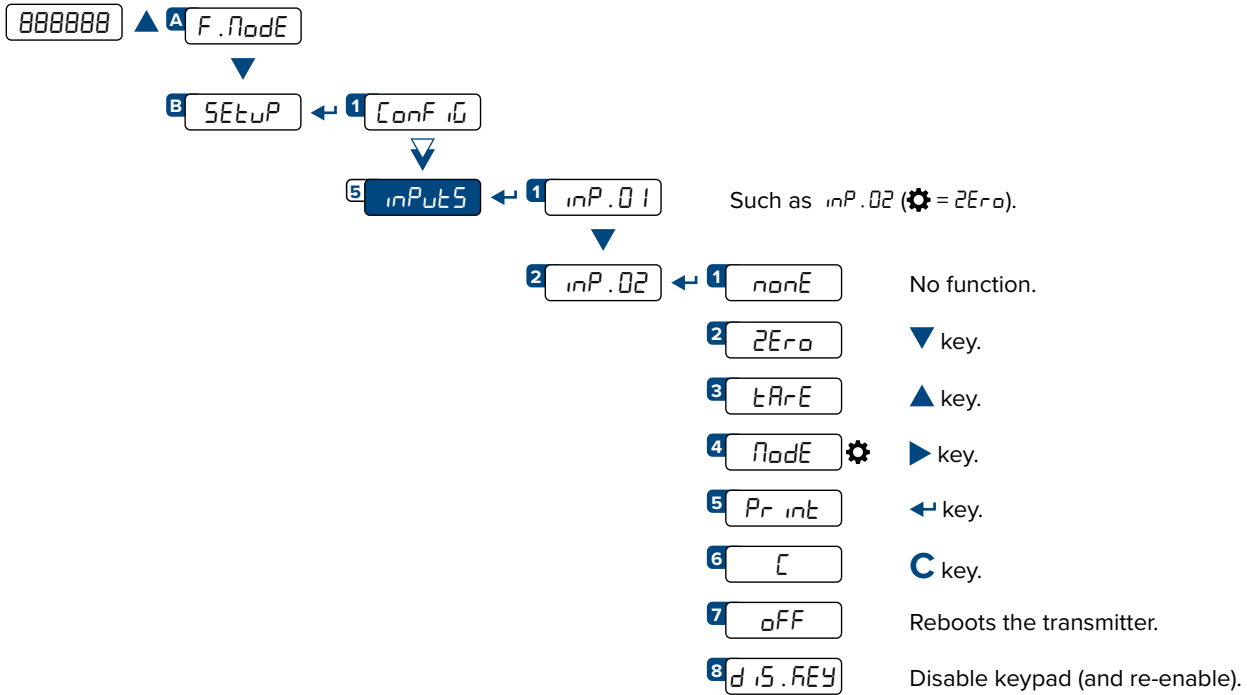

## INPUT CONNECTION:

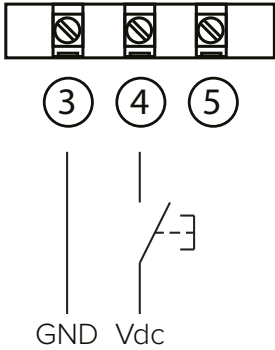

The input is activated when there is a potential difference between terminals 4 - 5 (IN1 and IN2) and terminal 3 (INCOM). The inputs are bidirectional, therefore it is possible to invert GND and Vdc.



Complete menu  
on pages 24 - 25

### MENU ACCESS:

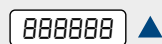

Press the ▲ key during the start-up procedure.

### SAVING THE PARAMETERS:

Press the C key several times, until the display shows `SEtUP`. Press the ← key to confirm.





# Output configuration

The indicator has 2 programmable outputs (photomosfet).

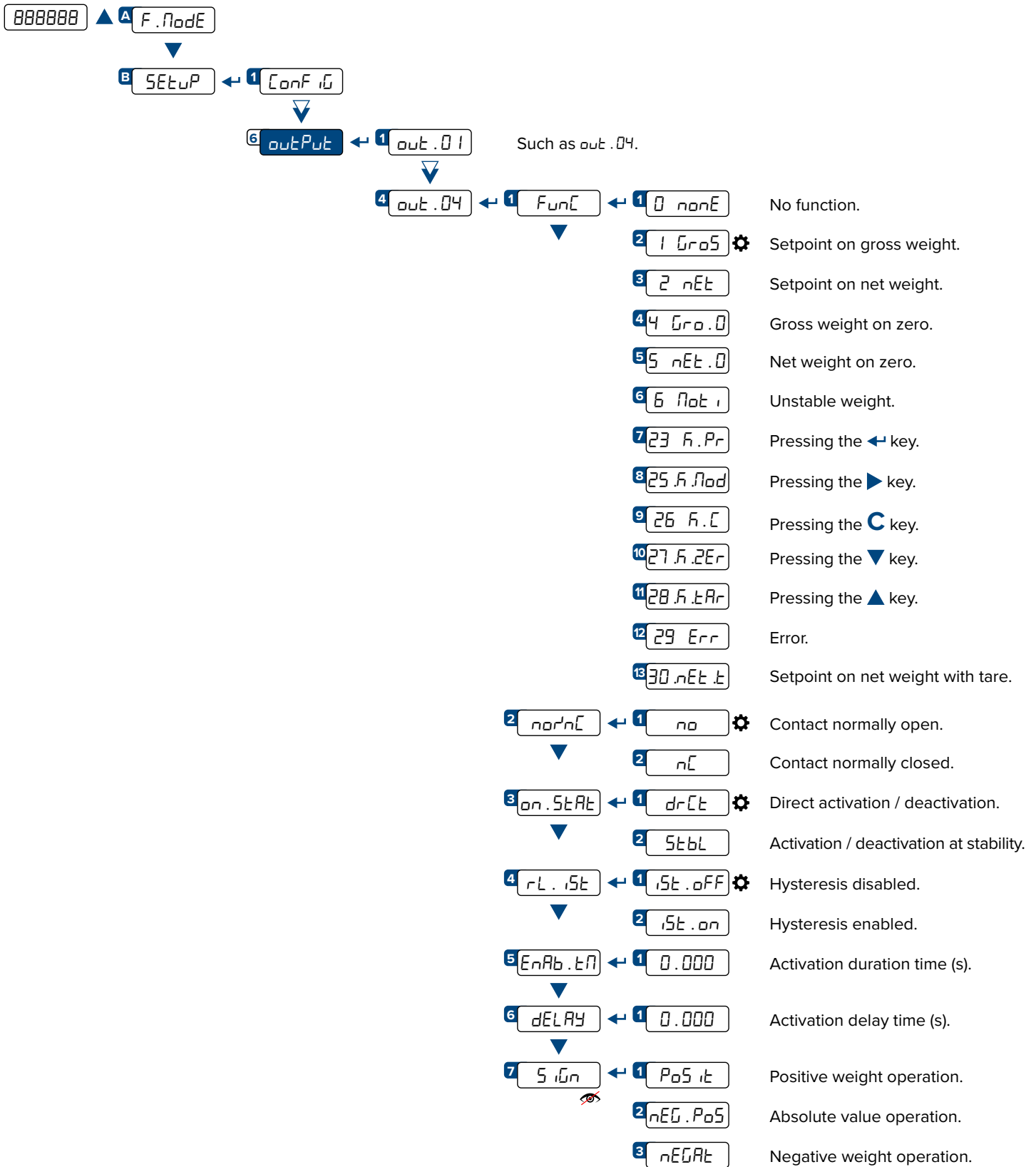

## LEGEND:

- Indicates repeated pressing of the ▼ key.
- Parameter visible only under certain conditions.
- Parameter or menu subject to approval.
- Default value of the parameter.

# Analog output configuration

The DGT1SX-AN model has an analog output in voltage (0 - 5 / 0 - 10 Vdc) or current (4 - 20 / 0 - 20 mA).

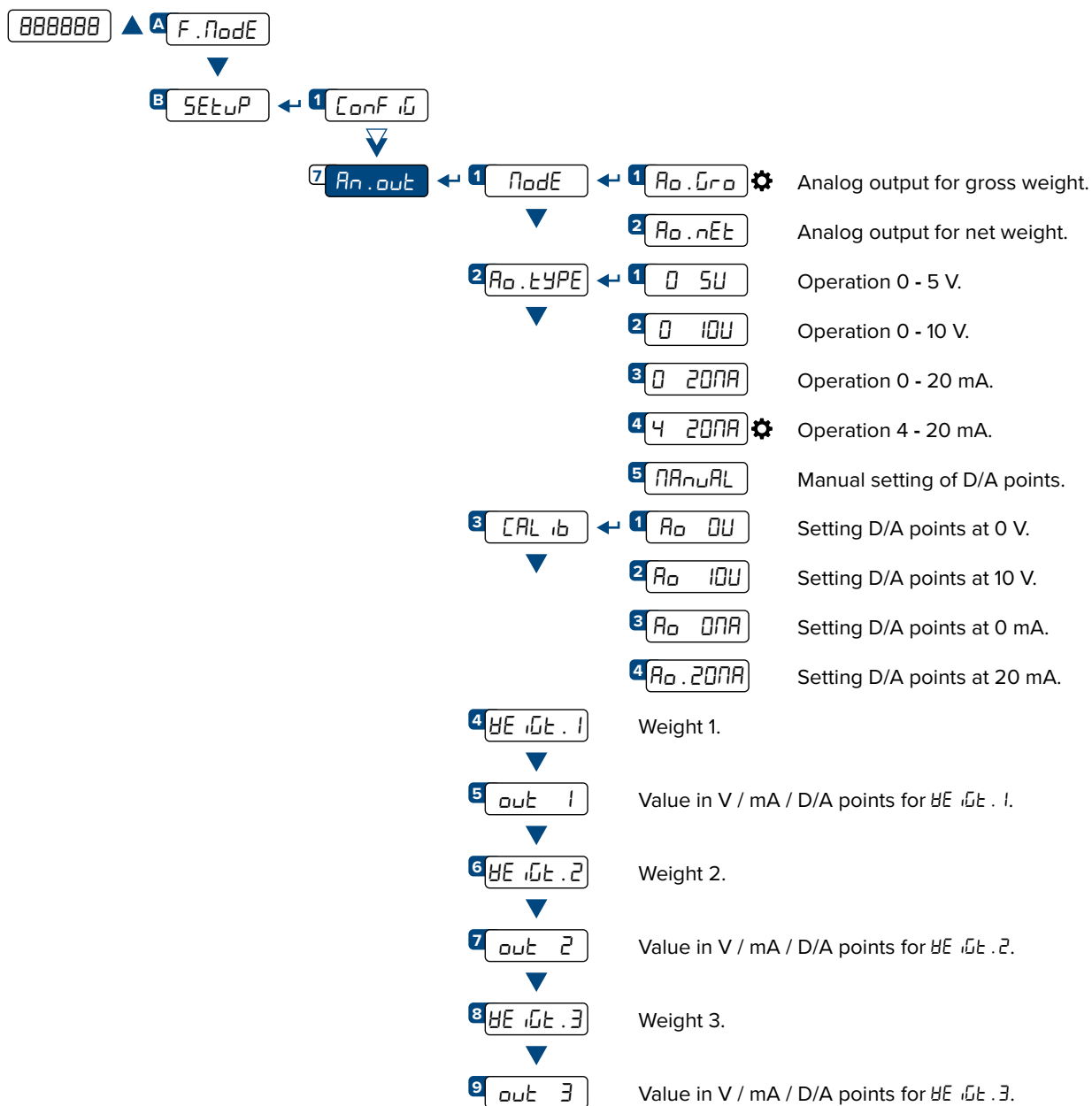

This menu allows an advanced configuration of the analog output.

For simple configurations, it is recommended to use the quick menu (Ref. **Quick Start Guide**).



Complete menu  
on pages 24 - 25

#### MENU ACCESS:

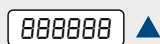

Press the **▶** key during the start-up procedure.

#### SAVING THE PARAMETERS:

Press the **C** key several times, until the display shows **SAVEP**. Press the **◀** key to confirm.



## CALIBRATION PROCEDURE:

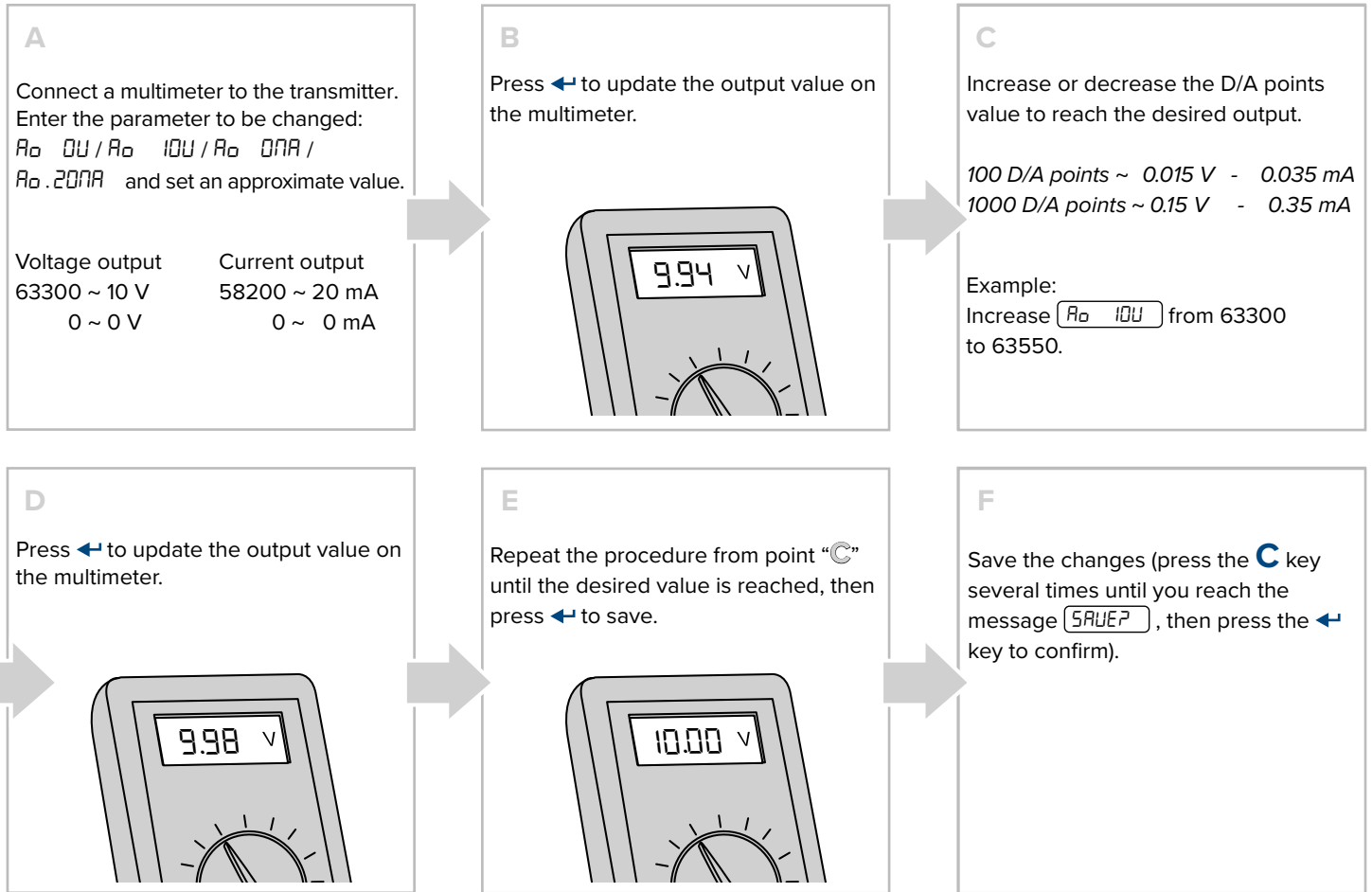

## ANALOG OUTPUT GRAPHS:

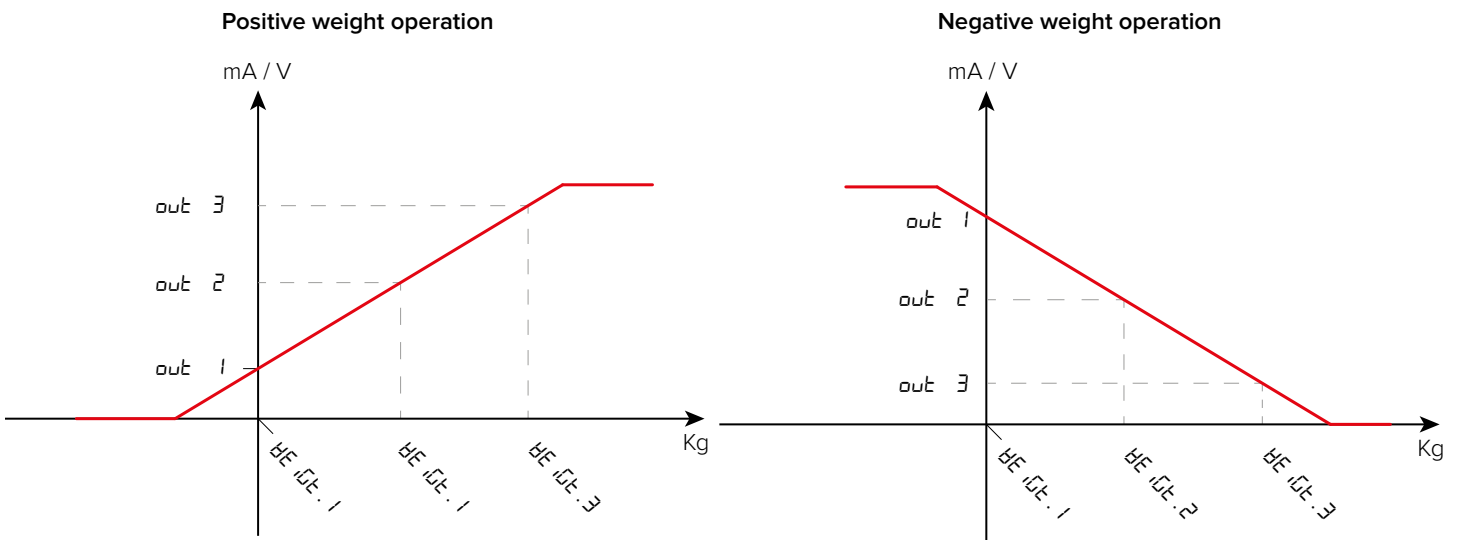

**i** Voltage or current operation is determined by the connection to the transmitter terminals:

Current: 9 (+) and 10 (-).  
Voltage: 11 (+) and 12 (-).

**LEGEND:**

- Indicates repeated pressing of the  $\nabla$  key.
- Parameter visible only under certain conditions.
- Parameter or menu subject to approval.
- Default value of the parameter.

# Serial communication configuration

All models are equipped with a micro-USB port that is always accessible for transmitter configuration and diagnostics. The DGT1SX and DGT1SX-AN models also have an RS485 port.

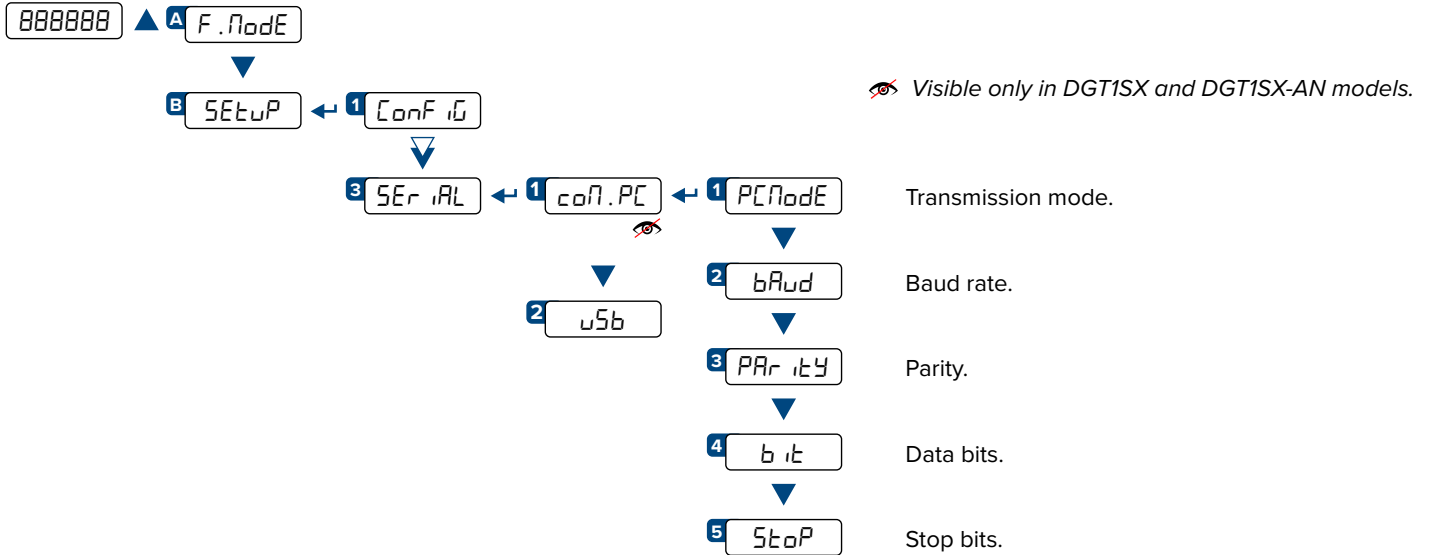

## Configuration of the USB port

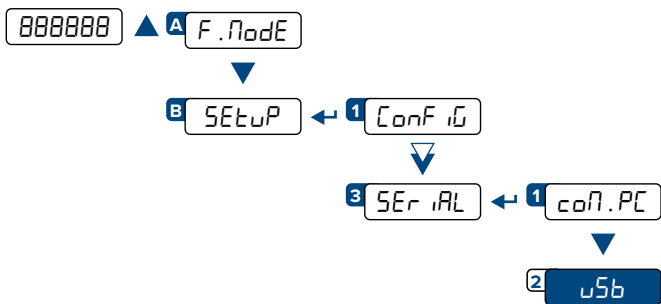

Useful for the configuration of the instrument from PC with Dinitools.



Complete menu on pages 24 - 25

### MENU ACCESS:

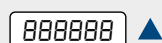

Press the ▲ key during the start-up procedure.

### SAVING THE PARAMETERS:

Press the C key several times, until the display shows SAUEP. Press the ← key to confirm.



# Configuration of the 485 port (PC port)

## Transmission mode

- |   |        |   |    |           |  |
|---|--------|---|----|-----------|--|
| 1 | PCModE | ← | 1  | ondE      | Transmission on demand.  |
|   |        |   | 2  | rEPE.6    | Transmission of the weight on DINI ARGEO 6-digit repeater.   |
| * |        |   | 3  | Pr in .St | Standard string transmission when the ← key is pressed.  |
| * |        |   | 4  | Pr in .EH | Extended string transmission when the ← key is pressed.  |
|   |        |   | 5  | 485       | Transmission with 485 protocol (enter the 485 address of the transmitter).                           |
|   |        |   | 6  | Modbus    | Transmission with Modbus protocol (refer to the Modbus protocol manual).                             |
|   |        |   | 7  | ALL .NAH  | Continuous high speed weight transmission for conversion applications (single channel only)          |
| * |        |   | 8  | ALL .Std  | Continuous transmission of the standard string (select the transmission frequency, about 1 ÷ 80 Hz). |
| * |        |   | 9  | ALL .EH   | Continuous transmission of the extended string (select the transmission frequency, about 1 ÷ 80 Hz). |
| * |        |   | 10 | StAb .St  | Stable transmission of the standard string.  |
| * |        |   | 11 | StAb .EH  | Stable transmission of the extended string.  |

\*

When selecting one of these protocols, you are asked if you want to display the 485 address at the beginning of the string:  
dEU . id ← YES / no.

## Baud rate, parity, data bits, stop bits

- |   |         |   |   |        |   |                                     |
|---|---------|---|---|--------|---|-------------------------------------|
| 2 | bAud    | ← | 1 | 9600   | ⚙ |                                     |
|   |         |   | 2 | 4800   |   |                                     |
|   |         |   | 3 | 2400   |   |                                     |
|   |         |   | 4 | 1200   |   |                                     |
|   |         |   | 5 | 115200 |   |                                     |
|   |         |   | 6 | 57600  |   |                                     |
|   |         |   | 7 | 38400  |   |                                     |
|   |         |   | 8 | 19200  |   |                                     |
| 3 | PAR ity | ← | 1 | nonE   | ⚙ | No parity, 8 data bits, 1 stop bit. |
|   |         |   | 2 | EUEn   |   | Even.                               |
|   |         |   | 3 | odd    |   | Odd.                                |
| 4 | bit     | ← | 1 | 8      | ⚙ | 8 bits.                             |
|   |         |   | 2 | 7      |   | 7 bits.                             |
| 5 | StoP    | ← | 1 | 1      | ⚙ | 1 stop bit.                         |
|   |         |   | 2 | 2      |   | 2 stop bits.                        |

### LEGEND:

⏴ Indicates repeated pressing of the ⏴ key.

👁 Parameter visible only under certain conditions.

🔒 Parameter or menu subject to approval.

⚙ Default value of the parameter.



## Standard string

**[01]ST,GS, 0.0,kg<CR><LF>**

Where:

<b>01</b>	Transmitter code 485 (2 characters), only if communication mode 485 is enabled
<b>ST</b>	Scale status (2 characters): <u>US</u> - Unstable weight <u>ST</u> - Stable weight <u>OL</u> - Weight overload (out of range) <u>UL</u> - Weight underload (out of range)
<b>,</b>	Character ASCII 044
<b>GS</b>	Type of weight data (2 characters) <u>GS</u> - Gross <u>NT</u> - Net <u>VL</u> - Microvolts <u>RZ</u> - Converter points
<b>,</b>	Character ASCII 044
<b>0.0</b>	Weight (8 characters including the decimal point)
<b>,</b>	Character ASCII 044
<b>kg</b>	Unit of measurement (2 characters)
<b>&lt;CR&gt;&lt;LF&gt;</b>	Transmission terminator, characters ASCII 013 and ASCII 010

## Extended string

**[01]1ST,1, 0.0,PT 20.8, 0,kg,01/02/19 11:12:13<CR><LF>**

Where:

<b>01</b>	Transmitter code 485 (2 characters), only if communication mode 485 is enabled
<b>1</b>	Number of the active scale
<b>ST</b>	Scale status (2 characters): <u>US</u> - Unstable weight <u>ST</u> - Stable weight <u>OL</u> - Weight overload (out of range) <u>UL</u> - Weight underload (out of range)
<b>,</b>	Character ASCII 044
<b>0.0</b>	Weight (8 characters including the decimal point)
<b>,</b>	Character ASCII 044
<b>PT</b>	Preset tare indication
<b>20.8</b>	Tare (8 characters including the decimal point)
<b>,</b>	Character ASCII 044
<b>0</b>	Character ASCII 048
<b>,</b>	Character ASCII 044
<b>kg</b>	Unit of measurement (2 characters)
<b>,</b>	Character ASCII 044
<b>01/02/19 11:12:13</b>	dd/mm/yy hh:mm:ss (only with REXD command and optional clock card)
<b>&lt;CR&gt;&lt;LF&gt;</b>	Transmission terminator, characters ASCII 013 and ASCII 010

## Serial commands

By selecting the PC port on demand mode (*andÉ*), you can communicate with the transmitter via serial commands. For each command received, the transmitter emits a string containing the response (refer to the command description) or one of the following signals:

<b>OK&lt;CRLF&gt;</b>	Command sent when sending a correct command. This response does not imply that the command is executed.
<b>ERR01&lt;CRLF&gt;</b>	Command sent correctly but followed by letters entered unintentionally (e.g. READF, TARES).
<b>ERR02&lt;CRLF&gt;</b>	Incorrect command data.
<b>ERR03&lt;CRLF&gt;</b>	Command sent not allowed (transmitter busy, or not used in the selected operating mode).
<b>ERR04&lt;CRLF&gt;</b>	Command sent non-existent.

**i** If the 485 protocol has been selected, you must precede the command with the transmitter address (e.g. 01READ).

### WEIGHT READING (standard string)

<b>Format</b>	R   E   A   D   <CRLF>
<b>Response</b>	Standard string<CR LF>.

### EXTENDED WEIGHT READING

<b>Format</b>	R   E   X   T   <CRLF>
<b>Response</b>	Extended string<CR LF>.

### WEIGHT READING IN HIGH RESOLUTION (X10)

<b>Format</b>	G   R   1   0   <CRLF>
<b>Response</b>	Standard string with weight in resolution x10 <CR LF>.

### AUTOMATIC TARE

<b>Format</b>	T   A   R   E   [!]   <CRLF>
<b>Response</b>	OK<CR LF> (or ERRxx).

Send the TARE! command to perform tare without stability control.

### MANUAL TARE

<b>Format</b>	T   M   A   N   t   t   t   t   t   t   <CRLF>
<b>Where</b>	ttttt tare value
<b>Response</b>	OK<CR LF> (or ERRxx).

By entering a manual tare value of 0, the tare on the scale is cleared.

### ZEROING

<b>Format</b>	Z   E   R   O   [!]   <CRLF>
<b>Response</b>	OK<CR LF> (or ERRxx).

Send the ZERO! command to perform zeroing without stability control.

### DISABLING KEYPAD

<b>Format</b>	K   E   Y   E   D   <CRLF>
<b>Response</b>	OK<CR LF> (or ERRxx).

### ENABLING KEYPAD

<b>Format</b>	K   E   Y   E   E   <CRLF>
<b>Response</b>	OK<CR LF> (or ERRxx).

### READING INPUTS

<b>Format</b>	I   N   P   U   n   <CRLF>
<b>Where</b>	n Input (1 / 2).
<b>Response</b>	I   N   P   U   n   v   v   v   v   <CRLF>
<b>Where</b>	n Input number. vvv Input status: 0000 = Not active. 0001 = Active. FFFF = Input reading error.

### READING OUTPUTS

<b>Format</b>	O   U   T   S   n   <CRLF>
<b>Where</b>	n Output (1 / 4).
<b>Response</b>	O   U   T   S   n   v   v   v   v   <CRLF>
<b>Where</b>	n Output number. vvv Output status: 0000 = Not active. 0001 = Active. FFFF = Output reading error.



## PRESSING A KEY

Format	K	E	Y	P	x	x	<CR LF>
Where	xx	Key code.					
	00	▼					
	01	▲					
	02	▶					
	03	←					
	04	C					



To simulate pressing a key, you must send the KEYP and KEYR commands in succession. If more than 1.5 s pass after the KEYP command is sent, the transmitter will execute the function associated with prolonged pressing of the key.

Response	OK<CR LF> (or ERRxx).
----------	-----------------------

## RELEASING A KEY

Format	K	E	Y	R	<CR LF>
--------	---	---	---	---	---------

Response	OK<CR LF> (or ERRxx).
----------	-----------------------

## BRIDGE BETWEEN THE SERIAL PORTS

Format	B	R	I	D	G	E	1	<CR LF>
--------	---	---	---	---	---	---	---	---------

Response	OK<CR LF> (or ERRxx).
----------	-----------------------

## SCALE INFORMATION

Format	R	A	L	L	<CR LF>
--------	---	---	---	---	---------

Response	s	s	,	b	,	N	N	N	N	N	N	u	u	,	L	L	L	L	L	L	u	u	,
	Y	Y	T	T	T	T	T	T	u	u	,	S	S	S	,	A	A	A	,	C	C	C	C
	,	,	R	R	R	R	R	-	I	I	I	I	I	I	I	<CR LF>							

Where	ss	UL = Underload. OL = Overload. ST = Stable weight. US = Unstable weight.
	b	Number of the active scale.
	NNNNNNuu	Net weight with unit of measurement.
	LLLLLuu	Gross weight with unit of measurement.
	YY	PT if a manual tare is present or “ ”.
	TTTTTuu	Tare with unit of measurement.
	SSS	Scale status: 000 = scale weighing. 001 = entering a numerical value. 002 = scale in technical menu.
	AAA	Counter keys pressed: 0001 = ▼ 0002 = ▲ 0003 = ▶ 0004 = ← 0170 = C
	CCCC	Code of last key pressed.
	RRRRR	Last rewrite number saved to Alibi memory.
	IIIIII	Last ID number saved to Alibi memory.



### READING OF MICROVOLTS

Format	M	V	O	L
Response	Standard string<CR LF>.			

### READING OF CONVERTER POINTS

Format	R	A	Z	F
Response	Standard string<CR LF>.			

### INITIALISING ALIBI MEMORY

Format	A	L	D	L
Response	ALDLOK / ALDLNO <CR LF>			

### WEIGHT READING WITH DATE AND TIME

Format	R	E	X	D
Response	Extended string<CR LF>.			

### READING A WEIGHING OPERATION IN THE ALIBI MEMORY

Format	A	L	R	D	X	X	X	X	X	-	Y	Y	Y	Y	Y	Y	<CR LF>
Response	b	,	L	L	L	L	L	L	L	L	L	L	u	u	,		
	Y	Y	T	T	T	T	T	T	T	T	T	T	u	u	<CR LF>		
Where	b		Scale number.														
	LLLLLLLLLuu		Gross weight with unit of measurement.														
	YY		"PT if a manual tare is present or " ".														
	TTTTTTTTTuu		Tare with unit of measurement.														

### SAVING A WEIGHING OPERATION IN THE ALIBI MEMORY

Format	P	I	D	<CR LF>																				
Response	P	I	D	S	T	,	b	,	L	L	L	L	L	L	L	L	L	L	u	u	,	Y	Y	
	T	T	T	T	T	T	T	T	T	T	T	u	u	,	X	X	X	X	X	-	Y	Y	Y	Y
	Y	Y	<CR LF>																					
Where	b		Scale number.																					
	LLLLLLLLLuu		Gross weight with unit of measurement.																					
	YY		"PT if a manual tare is present or " ".																					
	TTTTTTTTTuu		Tare with unit of measurement.																					
	XXXXXX		Rewrite number.																					
YYYYYY		ID number.																						

 The fieldbus protocol is described in the respective manual.

## MODBUS REGISTERS FOR DATA READING (SINGLE SCALE)

Data	Register	DESCRIPTION
Gross Weight	30001	Gross weight value.
	30002	
Net Weight	30003	Net weight value.
	30004	
Input status register	30005	Bit 15 <sup>(msb)</sup> Active channel. Bit 14 <sup>(msb)</sup> Active channel. Bit 13 No function. Bit 12 No function. Bit 11 No function. Bit 10 No function. Bit 9 Input no. 2 status. Bit 8 <sup>(lsb)</sup> Input no. 1 status.
		Bit 7 <sup>(msb)</sup> Gross zero zone (0 = "outside zone 0"; 1 = "in zone 0"). Bit 6 <sup>(msb)</sup> Tare PT (1 = a preset tare is active). Bit 5 Tare (1 = a tare is active). Bit 4 Overload condition (0 = No; 1 = Overload). Bit 3 Underload condition (0 = No; 1 = Underload). Bit 2 Stability (0 = Unstable; 1 = Stable). Bit 1 Gross weight sign (0 = "+"; 1 = "-"). Bit 0 <sup>(lsb)</sup> Net weight sign (0 = "+"; 1 = "-").
Command status register	30006	Last command received.
		Bit 7 <sup>(msb)</sup> Last command result. Bit 6 <sup>(msb)</sup> Last command result. Bit 5 Last command result. Bit 4 Last command result. Bit 3 Processed command count. Bit 2 Processed command count. Bit 1 Processed command count. Bit 0 <sup>(lsb)</sup> Processed command count.
Output status register	30007	No function.
		Bit 7 <sup>(msb)</sup> No function. ... Bit 2 No function. Bit 1 Digital output 1 status (0 = OFF; 1 = ON). Bit 0 <sup>(lsb)</sup> Digital output 2 status (0 = OFF; 1 = ON).
$\mu$ V Channel 1	30111	$\mu$ V value.



This manual contains the main registers for reading data / sending commands. Refer to the Modbus protocol manual for a complete list of available registers.

## MODBUS REGISTERS FOR SENDING COMMANDS

Data	Register	DESCRIPTION																		
<i>Command</i>	40001	Main commands available:																		
		<table border="1"> <thead> <tr> <th>Value</th> <th>Command</th> </tr> </thead> <tbody> <tr> <td>00 Hex</td> <td>No command</td> </tr> <tr> <td>01 Hex</td> <td>Zero</td> </tr> <tr> <td>02 Hex</td> <td>Tare</td> </tr> <tr> <td>03 Hex</td> <td>Predetermined tare</td> </tr> <tr> <td>0A Hex</td> <td>Setting setpoint 1</td> </tr> <tr> <td>0B Hex</td> <td>Setting setpoint 2</td> </tr> <tr> <td>19 Hex</td> <td>Setting digital outputs</td> </tr> <tr> <td>22 Hex</td> <td>Rebooting the transmitter</td> </tr> </tbody> </table>	Value	Command	00 Hex	No command	01 Hex	Zero	02 Hex	Tare	03 Hex	Predetermined tare	0A Hex	Setting setpoint 1	0B Hex	Setting setpoint 2	19 Hex	Setting digital outputs	22 Hex	Rebooting the transmitter
		Value	Command																	
		00 Hex	No command																	
		01 Hex	Zero																	
		02 Hex	Tare																	
		03 Hex	Predetermined tare																	
		0A Hex	Setting setpoint 1																	
		0B Hex	Setting setpoint 2																	
19 Hex	Setting digital outputs																			
22 Hex	Rebooting the transmitter																			
<i>Parameter 1</i>	40002	First command parameter. The parameter is always expressed as an absolute value (no decimal / sign).																		
	40003																			
<i>Parameter 2</i>	40004	Second command parameter. The parameter is always expressed as an absolute value (no decimal / sign).																		
	40005																			

### EXAMPLE 1

To reset the weight on the scale:

2. Set the command in register 40001

Byte	Value
1	00 Hex
2	01 Hex

### EXAMPLE 2

To set a predetermined tare of 1000kg:

1. Set the value in parameter 1 (registers 40002-40003)
2. Set the command in register 40001

Byte	Value
1	00 Hex
2	03 Hex
3 <sub>(MSB)</sub>	00 Hex
4	00 Hex
5	03 Hex
6 <sub>(LSB)</sub>	E8 Hex



This manual contains the main registers for reading data / sending commands.  
Refer to the Modbus protocol manual for a complete list of available registers.

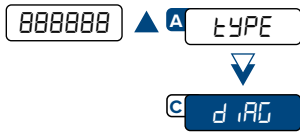

## Cells / converter test

**4** `RdC . uV` Display of the  $\mu\text{V}$  related to the weight on the scale.

For correct operation, the value of the  $\mu\text{V}$  of each channel must be less than 30000 with a weight equal to the maximum capacity. This value must be stable, and increase if a load is applied to the cell.

**5** `RdC . Pnt` Display of the A/D points of the converter related to the weight on the scale.

For correct operation, the value of A/D points must be stable, and increase if a load is applied to the cell.

## Firmware release

**1** `PrG . UEr` Display of firmware release (e.g. 0 1.06 .00).

## Serial number

**15** `SEr . nuPi` Display of transmitter serial number.

## Display

**8** `d iSPLA` Activation of all display segments and indicators.

## Keypad

**9** `FEYb` The code of last key pressed is shown on the display:

▼	8001
▲	8002
▶	8003
←	8004
C	80AA

Press the same key 3 consecutive times to exit.



Complete menu  
on pages 24 - 25

### MENU ACCESS:

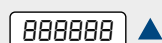

Press the ▲ key during the start-up procedure.

### SAVING THE PARAMETERS:

Press the C key several times, until the display shows `SAUEP`. Press the ← key to confirm.



## Serial ports

**10** 5Er

Bridge between serial ports (for manufacturer's use).

## Inputs

**13** inPut5

Checking the status of the inputs:

value 0 indicates that the input is disabled, value 1 indicates that the input is enabled.

Use the ▲ and ▼ keys to display the two inputs.

## Outputs

**12** outPut

Activation of the output shown on the display (rEL . 1 / rEL . 2).

Use the ▲ and ▼ keys to activate the two outputs.

## Analog output (mod. DGT1SX-AN)

**14** An.out

Analog output test.

Use the ▲, ▼, ► keys to enter the D/A point value of the analog output.

Press the ◀ key to confirm and update the V / mA value of the analog output.

## Programming the Setpoints

In weighing mode, if the output functions (1 Gross / 2 net) have been set correctly, pressing ◀ for **3 seconds** will enter the setpoint programming menu:

0.000 ◀ <sup>3s</sup> 5.1 on

Output 1 activation value.

5.1 off

Output 1 deactivation value.

 visible only if rL . iSt = iSt . on

5.2 on

Output 2 activation value.

5.2 off

Output 2 deactivation value.

 visible only if rL . iSt = iSt . on

Once you have entered the desired values, press C. The display shows "5ErE" and returns to weighing mode.

### LEGEND:

 Indicates repeated pressing of the ▼ key.

 Parameter visible only under certain conditions.

 Parameter or menu subject to approval.

 Default value of the parameter.



## Restoring factory settings

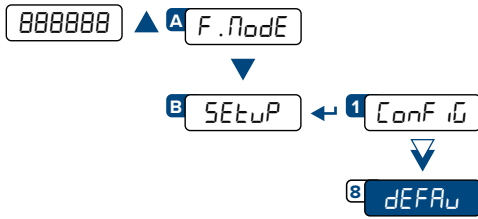

The transmitter is initialized and the default parameters (indicated by the ⚙️ symbol) are activated. Pressing ← the display shows “dFLt?” confirm further with ← or exit by pressing another key.

The actual activation of the default parameters is performed by saving the settings (SAUEP) while exiting the menu.

## Date and time setting

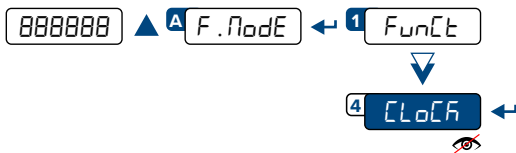

Visible only with optional clock card

- DAY** Set the day and press ←.
- Month** Set the month and press ←.
- YEAR** Set the year (with two digits) and press ←.
- hour** Set the hour and press ←. The time format is 24h.
- minute** Set the minutes and press ←.



The date and time format is: DD/MM/YY, HH:MM:SS (24h),



Complete menu  
on pages 24 - 25

### MENU ACCESS:

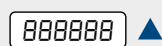





Press the ▲ key during the start-up procedure.

### SAVING THE PARAMETERS:

Press the C key several times, until the display shows SAUEP. Press the ← key to confirm.

Alarm	Description
$P_{rEC}$	Displayed if you try to calibrate a point without first confirming the number of calibration points ( $n \neq P$ ).
$Er_{.NoE}$	Calibration error: unstable weight during point acquisition.
$Er_{PnE}$	Calibration error: during the acquisition of a calibration point a NULL value was read from the converter.
$Err_{.H.1}$	Error that occurs if the capacity of channel $H$ is not set, or there is an error in the calibration parameters of channel $H$ , where $H$ indicates the number of the channel to which the error refers.
$oUEr_H$	Error that occurs if the capacity of channel $H$ is not set, or there is an error in the calibration parameters of channel $H$ , where $H$ indicates the number of the channel to which the error refers.
$Er_{11}$	Calibration error: a sample weight that is too low was used; it is recommended to use a weight of at least half the scale's capacity.
$Er_{12}$	Calibration error: The acquired calibration point ( $tP_1 / tP_2 / tP_3$ ) is equal to the zero point ( $tP_0$ ).
$Er_{37}$	Scale to be calibrated (we recommend resetting the transmitter to the factory default "dEFALU" settings before proceeding).
$Er_{39}$	Scale to be calibrated (we recommend resetting the transmitter to the factory default "dEFALU" settings before proceeding).
$CEr_{-36}$	Negative internal points were calculated during calibration: <ul style="list-style-type: none"> <li>the calibration point is below the zero point;</li> <li>the signal is negative (check the connections).</li> </ul>
$CEr_{-37}$	Internal points below the minimum value were calculated during calibration: <ul style="list-style-type: none"> <li>the calibration point is equal to the zero point;</li> <li>too high a capacity has been set with respect to the division.</li> </ul>
$hb_{.Err}$	Hardware error: software not compatible with the installed hardware.
$AL_{.Err}$	Displayed when the alibi memory is enabled and the transmitter does not detect the presence of the card when the power is turned on. The $COU$ function is set automatically, but not saved in the setup environment.
$bUSY$	Printing in progress (printer serial port busy) or transmitter waiting to transmit a print to PC.
$unStAb$	You are trying to print with an unstable weight.
$un.oUEr$	You are trying to print with the weight in underload / overload.
-----	The weight is overloaded (9 divisions over the maximum capacity).
-----	The weight is underloaded.
	Approved transmitter: -100 divisions.
	Non-approved transmitter: -maximum capacity -9 divisions.
$Gros_{.Er}$	You are trying to print with a non-positive gross weight (less than or equal to zero).
$net_{.Err}$	You are trying to print with a non-positive net weight (less than or equal to zero).
$no_{.0}_{.unS}$	Weight not passed by net 0 or instability.
$COU$	You are trying to print while the transmitter is converting the unit of measurement.
$Err_{.CLH}$	Communication problems with the clock card of the transmitter.
$CEL_{.Err}$	Signal anomaly: check the connection of the cells.

## LEGEND:

-  Indicates repeated pressing of the  key.
 Parameter visible only under certain conditions.
 Parameter or menu subject to approval.
 Default value of the parameter.













A RICE LAKE WEIGHING SYSTEMS COMPANY

**HEAD OFFICE**

Via Della Fisica, 20  
41042 Spezzano di Fiorano, Modena - Italy  
Tel. +39 0536 843418 - Fax +39 0536 843521

**SERVICE ASSISTANCE**

Via Dell'Elettronica, 15  
41042 Spezzano di Fiorano, Modena - Italy  
Tel. +39 0536 921784 - Fax +39 0536 926654

[www.diniargeo.com](http://www.diniargeo.com)

Stamp of the authorized service center

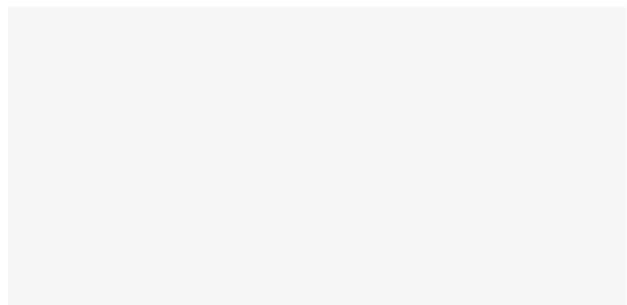

The information in this document is approximate and can be subject to variations without prior notice by Dini Argeo. In compliance with the norms in force, the official technical data are available in the updated version on the following website [www.diniargeo.com](http://www.diniargeo.com) or by contacting Dini Argeo Customer Service.

**USER\_MAN\_ENG\_DGT15X**  
Rev. 25.08.2021