

USER MANUAL WEIGHT INDICATOR

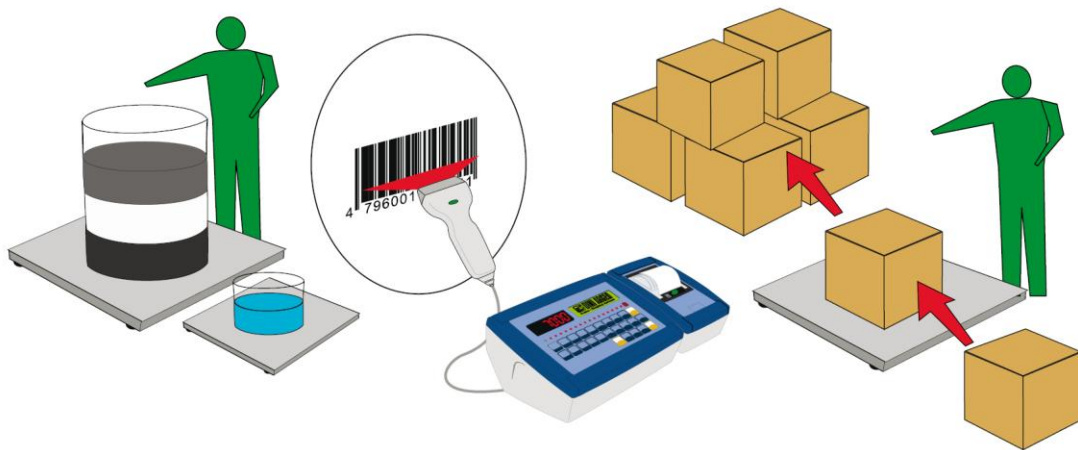

E-AF01: PROGRAM VERSION FOR TOTALIZATIONS AND SIMPLE DOSAGES



3590EKR, 3590EXP, 3590EDX, 3590EXT, CPWE, CPWET series indicator



INDEX

1. INTRODUCTION	5
2. MAIN TECHNICAL SPECIFICATIONS	6
2.1 ACCESSORIES AVAILABLE	7
2.2 SYMBOLS USED	7
3. INSTALLATION	8
3.1 CPWE DRILLING TEMPLATE, CASE AND DIMENSION	8
3.2 3590E CASE AND DIMENSIONS	9
3.3 CPWET CASE AND DIMENSIONS	11
3.4 CPWETD CASE AND DIMENSIONS	12
3.5 POWER SUPPLY & START UP	13
3.6 START UP	13
3.7 TURNING OFF THE INSTRUMENT	13
3.8 TURNING ON PRINTER IN ENERGY SAVING MODE	14
4. FRONT PANEL KEYS AND DISPLAYS	14
4.1 FUNCTION OF THE KEYS	17
4.1.1 "2ndF" KEY: SECOND FUNCTION OF THE KEYS	18
4.1.2 ENTERING ALPHANUMERIC TEXT	19
4.1.3 DISABLING THE KEYBOARD	19
4.1.4 HELP MENU	20
4.1.5 INDICATOR CONNECTED TO PC KEYBOARD	20
4.1.5.1 DIRECT COMPILATION OF INPUT TEXT	20
4.1.6 REMOTE CONTROL	21
4.1.6.1 "19-KEY" INFRARED REMOTE CONTROL	21
4.1.6.2 "6-KEY" RADIO REMOTE CONTROL	22
4.2 FUNCTION DISPLAY	23
4.2.1 WEIGHT ZOOM	23
4.2.2 STATUS INDICATORS	24
4.2.3 BATTERY LEVEL INDICATION	25
4.2.4 "TILT" DEVICE	25
4.2.5 DISPLAYED DATA	26
5. SCALE SELECTION	31
5.1 FUNCTIONING WITH REMOTE SCALE	32
6. SCALE ZERO FUNCTION	32
6.1 CYCLICAL AUTOMATIC ZERO	32
7. TARE FUNCTIONS	33
7.1 SEMIAUTOMATIC TARE	33
7.2 PRESET TARE	33
7.3 CALCULATED MANUAL TARE	33
7.4 TARE DATABASE	33
7.4.1 ENTRY	34
7.4.2 MODIFICATION	34
7.4.3 CANCELLATION	34
7.4.4 PRINTING	34
7.4.5 SELECTION	34
7.4.6 HELP	35
7.5 TARE CANCELLATION	35
7.6 LOCKED/UNLOCKED TARE	35
7.7 LIMITATION OF THE TARE FUNCTIONS	35
7.8 LINKING OF A PRESET TARE WITH AN ARTICLE IN THE DATABASE	35
7.9 EXECUTION MODE / DISABLING OF THE TARE	35
7.10 AUTOMATIC TARE AFTER THE TOTALISATION	36
7.11 FIRST TARE OPERATION IN FORMULATION	36
7.12 RESTORING TARE AND ZERO AT THE START-UP	36
8. MULTIRANGE AND MULTIDIVISION FUNCTION	36
9. DISPLAY OF METRIC DATA (inFO)	36
10. FILLING IN THE INPUT TEXT	37
10.1 QUICK MODIFICATION OF AN INPUT TEXT	37
11. DATABASE	38

11.1 ARTICLES	38
11.1.1 ENTRY	38
11.1.2 MODIFICATION	39
11.1.3 CANCELLATION	39
11.1.4 PRINTING	39
11.1.5 SELECTION / DESELECTION	39
11.1.6 ENTRY, MODIFICATION AND QUICK SELECTION OF ARTICLE 000	39
11.1.7 ALPHABETICAL RESEARCH	40
11.1.8 HELP	40
11.2 CUSTOMERS	40
11.2.1 ENTRY	40
11.2.2 MODIFICATION	41
11.2.3 CANCELLATION	41
11.2.4 PRINTING	41
11.2.5 SELECTION / DESELECTION	41
11.2.6 ENTRY, MODIFICATION AND QUICK SELECTION OF CUSTOMER 000	41
11.2.7 ALPHABETICAL RESEARCH	42
11.2.8 HELP	42
12. DATABASE ACCESS PASSWORD	42
13. WEIGHT TOTALISATION FUNCTIONS	42
13.1 TOTALISATION MODES	42
13.1.1 TOTALISER IN LOADING	43
13.1.2 TOTALISER IN UNLOADING	43
13.1.3 TOTALISER IN LOADING AS WELL AS IN UNLOADING	43
13.2 TOTALISATION WITH AUTOMATIC EXECUTION OF THE TARE	43
13.3 MANUAL OR AUTOMATIC TOTALIZATION	43
13.4 TOTALISATION DELAY	43
13.5 TOTALISATION FIELD	43
13.6 CONDITIONS FOR TOTALISATION	44
13.7 PRINT REENABLING AND TOTALISATION	44
13.8 VISUALISATION AND CLEARING OF THE ACCUMULATED TOTALS	44
13.9 CLEARING AND AUTOMATIC PRINTING OF THE PARTIAL TOTAL AFTER N WEIGHS	45
13.10 PROGRESSIVES	45
13.10.1 ADDITIONAL VALUE	45
13.10.2 PROGRESSIVE DIGITS	45
13.10.3 TICKET PROGRESSIVE	45
13.10.4 LOT PROGRESSIVE	45
14. PRINTOUTS	46
14.1 LINKING OF THE FORMATS TO THE PRINT FUNCTIONS	48
14.1.1 QUICK LINKING OF THE FORMATS	50
14.2 FORMATTING HEADING PRINTOUT	50
14.3 REPETITION OF THE LAST EXECUTED PRINTOUT	51
14.4 DEFAULT PRINTING FORMATS	51
15. OTHER FUNCTIONS	51
15.1 CALCULATOR	51
15.2 DISPLAY OF NET WEIGHT WITH SENSITIVITY X 10 (for testing use during calibration)	51
15.3 SETTING DATE / TIME	51
15.4 SET-POINT FUNCTION	52
15.4.1 NORMAL FUNCTIONING MODE	52
15.4.1.1 SETPOINT ON THE GROSS WEIGHT	52
15.4.1.2 SETPOINT ON THE NET WEIGHT	53
15.4.1.3 GROSS WEIGHT AT ZERO	53
15.4.1.4 NET WEIGHT AT ZERO	53
15.4.1.5 INSTABILITY	53
15.4.1.6 TOTALISATION	53
15.4.1.7 SETPOINT ON THE PARTIAL TOTAL	53
15.4.1.8 SETPOINT ON THE GENERAL TOTAL	53
15.4.1.9 SETPOINT ON THE GRAND TOTAL	53
15.4.1.10 SETPOINT ON THE NEGATIVE NET WEIGHT	53
15.4.2 EXCLUSIVE FUNCTIONING MODE	54

15.4.3 QUICK MODIFICATION OF THE SETPOINTS	54
15.4.4 FUNCTIONING OF CONTROL LIGHT	54
15.5 DIAGNOSTIC PERIPHERALS	54
15.6 COM DATA DIAGNOSTIC.....	55
15.7 UNIT OF MEASURE CONVERSION.....	55
16. ALIBI MEMORY	56
16.1 READING OF THE WEIGHS CARRIED OUT	57
16.2 SERIAL PROTOCOL FOR MANAGING THE ALIBI MEMORY:.....	57
16.2.1 REQUEST WEIGHT VALUE WITH WEIGH ID	57
16.2.2 STRING FORMAT (WEIGHT/ID)	58
16.2.3 WEIGH READING	58
16.2.4 ALIBI MEMORY CANCELLATION (only with non approved instrument)	58
17. MESSAGES	59
17.1 INSIDE THE SET-UP OR MENU OR AT START-UP.....	59
17.2 IN WEIGHING.....	60
DECLARATION OF CONFORMITY	61
WARRANTY	61

1. INTRODUCTION

This manual was created to help you install and learn all about the functional possibilities of the purchased indicator.

The instrument is suitable for use in various weighing environments.

Not only does it have all the normal features of high-precision scales, but it also gives you the possibility to work in specific environments due to the functioning modes contained in the software implemented in the FLASH MEMORY on the internal board; This makes the instrument extremely flexible and it can be used in many different industrial applications linked to weighing. The double numerical and interactive alphanumeric display, the alphanumeric and function keyboard, allow the operator an easy and immediate use and provide the microcontroller with DATA ENTRY functions in addition to the normal weighing functions. The input/output allows the instrument to control various external devices, to receive external commands, control a printer and communicate with a personal computer or to be inserted in a network of weight indicators controlled by a PC.



Please note that this instrument is covered by a warranty and **MUST NOT BE OPENED BY THE USER** for any reason whatsoever. Any attempt to repair or modify the unit exposes the user to the risk of electric shock and will invalidate the entire warranty.

If any problems are found in the unit or with the system in which it is used, the fact must be communicated to the manufacturer or the dealer from whom it was purchased.

In any case, **DISCONNECT THE POWER SUPPLY** before taking any action.

The version with the 6V rechargeable battery has to be completely recharged (12 hours) in the first installation of the instrument; we RECOMMEND disconnecting the battery if the instrument is not going to be used for more than 30 days. In order to avoid the deterioration of the rechargeable battery:

- In standard conditions, never leave the battery partially or completely uncharged; at least once a week recharge it completely.
- In case the instrument is not used for a long period, one needs to
 1. completely recharge the battery before the system is switched off for the last time;
 2. recharge completely every 3 months.

Do not pour liquids on the weight indicator.

Do not use solvents to clean the weight indicator.

Do not expose the instrument to direct sunlight nor place it near heat sources.

Place or anchor the weight indicator and platform on a non-vibrating base.

All the connections of the indicator have to be made respecting the rules applicable in the zone and in the installing environment.

Everything not expressly described in this manual has to be considered as improper use of the equipment.

READ CAREFULLY AND APPLY WHAT IS DESCRIBED IN SECTION 3.

Do not install in any area where there is a risk of explosion.



The crossed-out wheeled bin on the product means that at the product end of life, it must be taken to separate collection or to the reseller when a new equivalent type of equipment is purchased. The adequate differentiated refuse collection in having the product recycled, helps to avoid possible negative effects on the environment and health and supports the recycling of the materials of which the equipment is made. The unlawful disposal of the product by the user will entail fines foreseen by the current regulations.

2. MAIN TECHNICAL SPECIFICATIONS

POWER SUPPLY	<p>3590E:</p> <ul style="list-style-type: none"> - 12 Vdc (8 ÷ 24 Vdc in the IO versions), with internal 100 ÷ 240 Vac (50÷60 Hz) / 12 Vdc adapter. - 6 Vdc from rechargeable built-in battery, fitted depending on the model. <p>CPWE:</p> <ul style="list-style-type: none"> - 8 ÷ 24 Vdc - 6 Vdc from external rechargeable battery (upon request). <p>CPWET:</p> <ul style="list-style-type: none"> - 12 Vdc with external 100 ÷ 240 Vac (50÷60 Hz) / 12 Vdc adapter. - 6 Vdc from external rechargeable battery (upon request).
MAXIMUM POWER	16 VA.
OPERATING TEMPERATURE	From -15 to +40 °C (from 5 to 104 °F).
CONVERTER	24 bit Sigma Delta.
CONVERSION SPEED	200 conv./sec with automatic selection.
RANGE OF INPUT SIGNAL	0,6 mV/V - 3,2 mV/V.
MINIMUM VOLTAGE PER DIVISION	0.3 µV (approved instrument); 0.03 µV (non-approved instrument).
AUTOMATIC ZERO DETECTION	Only in gross mode, programmable at +/- ¼, ½, 1, 2 divisions.
ZERO RANGE	Configurable up to +/- 50% of max load capacity.
AUTO ZERO AT START-UP	Configurable up to +/- 50% of max load capacity.
LOAD CELL POWER SUPPLY	5Vdc ± 5%, 120mA (max 8 350-Ohm cells).
LOAD CELL CONNECTIONS	6 wires with Remote Sense.
DISPLAY DIVISIONS	10000e, 3 x 3000e for legal for trade weighing, expandable up to 800.000 for internal use (with minimum signal coming from the 1,6 mV/V cell).
DISPLAYS	<p>3590E:</p> <ul style="list-style-type: none"> - Red, high-luminosity LED indicators, with six digits (h 13 mm). - Back lit graphic 160x32 dot LCD. <p>CPWE: Back lit graphic 160x32 dot LCD.</p>
DATABASE/MEMORY	<p>Database of 1000 articles (3 lines of description of 20 characters).</p> <p>Database of 300 preset tares.</p> <p>Database of 200 customers (5 lines of 30 characters).</p>
SIGNALS	<p>3590E: 16 status LEDs. Graphic icons on LCD display.</p> <p>CPWE: Graphic icons on LCD display.</p> <p>CPWET: 3-way control light. Graphic icons on LCD display</p>
KEYBOARD	Impermeable polycarbonate keyboard (IP65 protection degree), with membrane keys with audible and tactile feedback.
PARAMETER SETUP	Calibration and linearity (up to 8 points), fully digital and programmable from the keyboard or from PC with Dinitools™.
CLOCK/DATE	Fitted, with buffer RAM.
SERIAL OUTPUTS	<ul style="list-style-type: none"> - 2 input/output RS232 ports on terminal board/ amp connector. - 1 input/output RS485 port on terminal board or RS232 on amp connector.
INPUTS AND OUTPUTS	<ul style="list-style-type: none"> - Management of PC keyboard or barcode reader <p>3590EXP, 3590EXT and CPWET:</p> <ul style="list-style-type: none"> - 2 optoisolated inputs (optoisolated photo couplers), 12Vdc – 24Vdc, 20mA max - 4 outputs (optoisolated photomofets), 48Vac / 0.15A, 60Vdc / 0.15A, 10 Ω max. <p>3590EXT in IO version and CPWE:</p> <ul style="list-style-type: none"> - 8 inputs (optoisolated photo couplers), 12Vdc – 24Vdc, 20mA max. - 16 outputs (optoisolated photomofets), 48Vac / 0.15A, 60Vdc / 0.15A.
ANALOGUE OUTPUT (Option available on the 3590EXT "IO" version and CPWE version)	- 16-bit analogue output configurable from keyboard (full-scale value; zero scale value and minimum value) from 0 to 10 Vdc or from 0 to 20mA; the maximum resistance applicable on the output current is 350 Ohm and the minimum resistance applicable on the output voltage is 10 kohm.





2.1 ACCESSORIES AVAILABLE

On the indicator it's possible to implement internal and external modules used to increase interfacing possibilities. (For example, the number of usable outputs various types of printers, in order to have a report of the weighs made, or giant display in order to better see the weigh operations. Also, one can connect a PC in order to simply program the instrument through Dinitools™, or in order to have a complete management of the weighs.

Contact the reseller for the list of the available hardware and software accessories.

2.2 SYMBOLS USED

Below are the symbols or text used in the manual to recall the reader's attention or on the instrument to recall the user's attention.

	ATTENTION! Only qualified personnel must perform this operation
	ATTENTION! This is referred to working with live wires: only qualified personnel must perform this operation.
	CE CONFORMITY
	IDENTIFIES THE CLASS OF PRECISION.
"TECH.MAN.REF."	It means that an advanced function is being described (therefore for the technical personnel) which will be further explained in the corresponding technical manual.

THE INSTRUMENT'S DANGEROUS VOLTAGE PARTS AND THE PARTS THE USER CAN ACCESS HAVE BEEN ELECTRICALLY INSULATED.

3. INSTALLATION

3.1 CPWE DRILLING TEMPLATE, CASE AND DIMENSION

The weight indicator has an anodized aluminium case, whose external dimensions are shown in the figure 1. It should be mounted on a panel board respecting the safety norms.

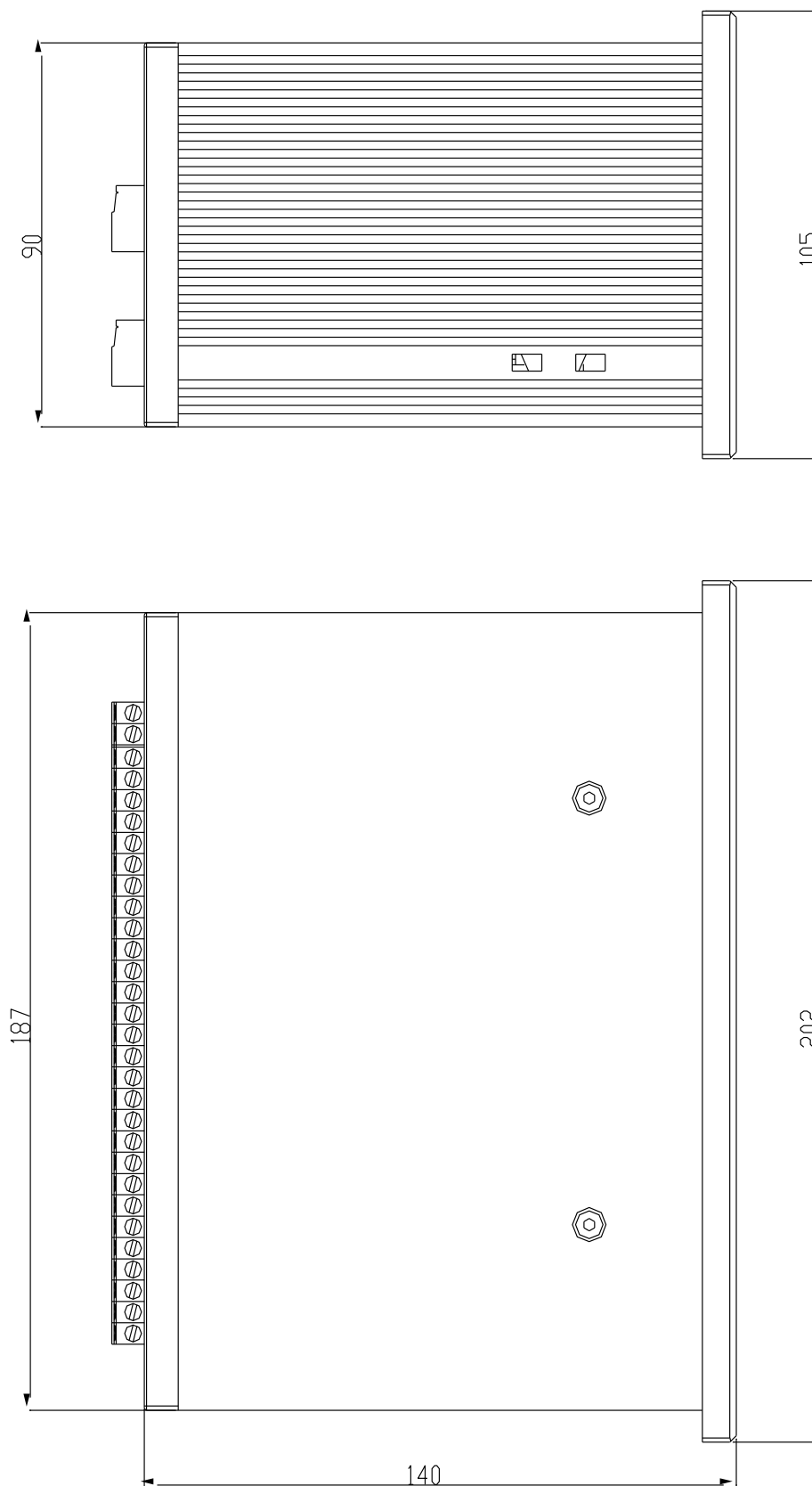

Figure 1 **DRILLING TEMPLATE DIMENSION: 187,5mm x 91,5mm**

3.2 3590E CASE AND DIMENSIONS

ABS MODEL

The indicator has an IP65 ABS case, whose external dimensions are shown in the Figure 2. It can be simply put on a table or fixed to a shelf or column available on request.

NOTE: If the identification plate is supplied separately (therefore not attached to the indicator), it is advisable to attach it to the indicator, in order to be able to identify the instrument.

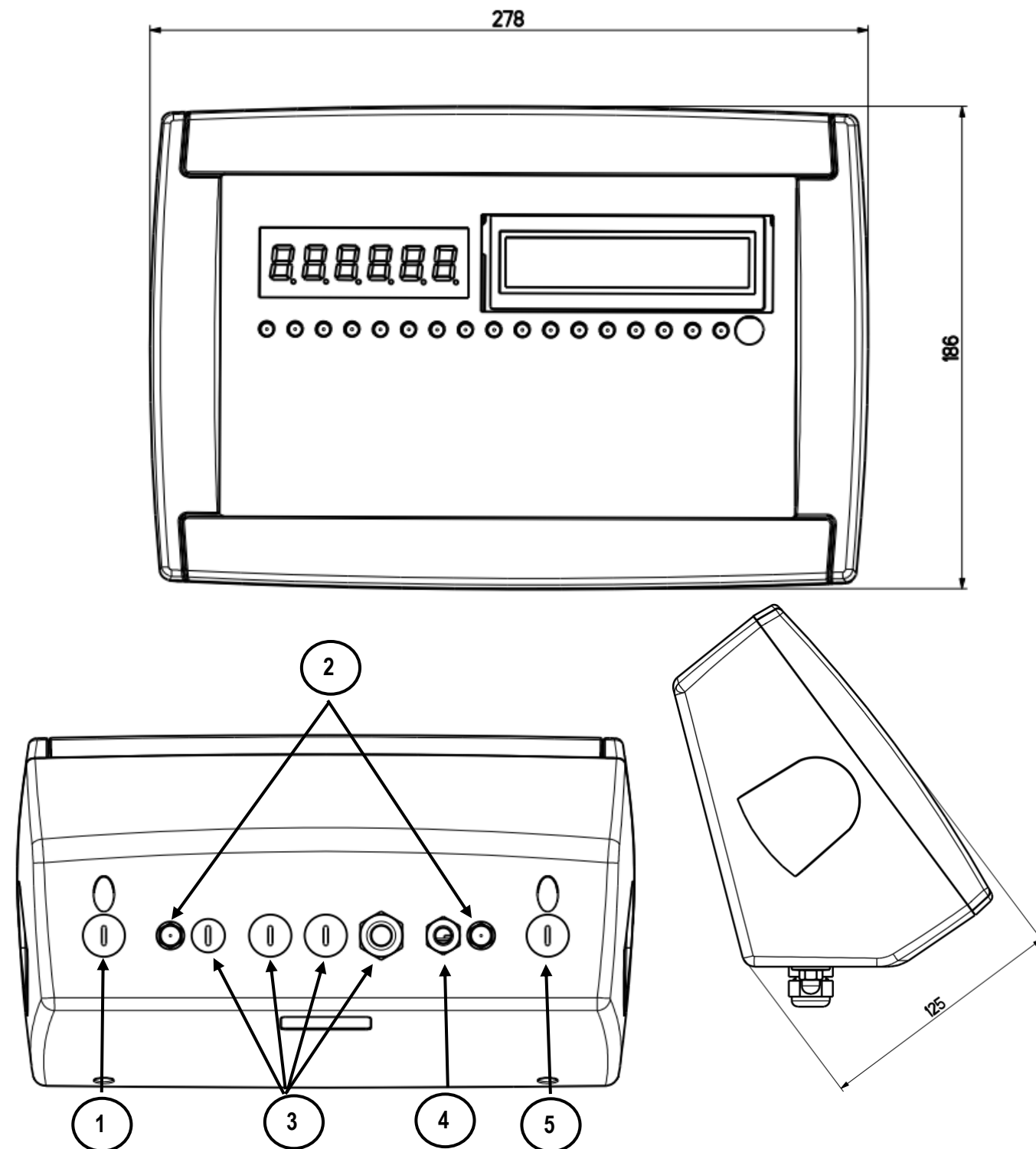

Figure 2 – Measurements and dimensions in mm

- 1) RJ11 connector
- 2) Fixing for shelf or column mounting
- 3/5) Available for load cells / serial lines / inputs / outputs.
- 4) Power supply input.

STAINLESS STEEL MODEL

The indicator has a STAINLESS STEEL case, whose external dimensions are shown in the Figure 3. It can be simply put on a table or fixed to a shelf or column available on request.

NOTE: If the identification plate is supplied separately (therefore not attached to the indicator), it is advisable to attach it to the indicator, in order to be able to identify the instrument.

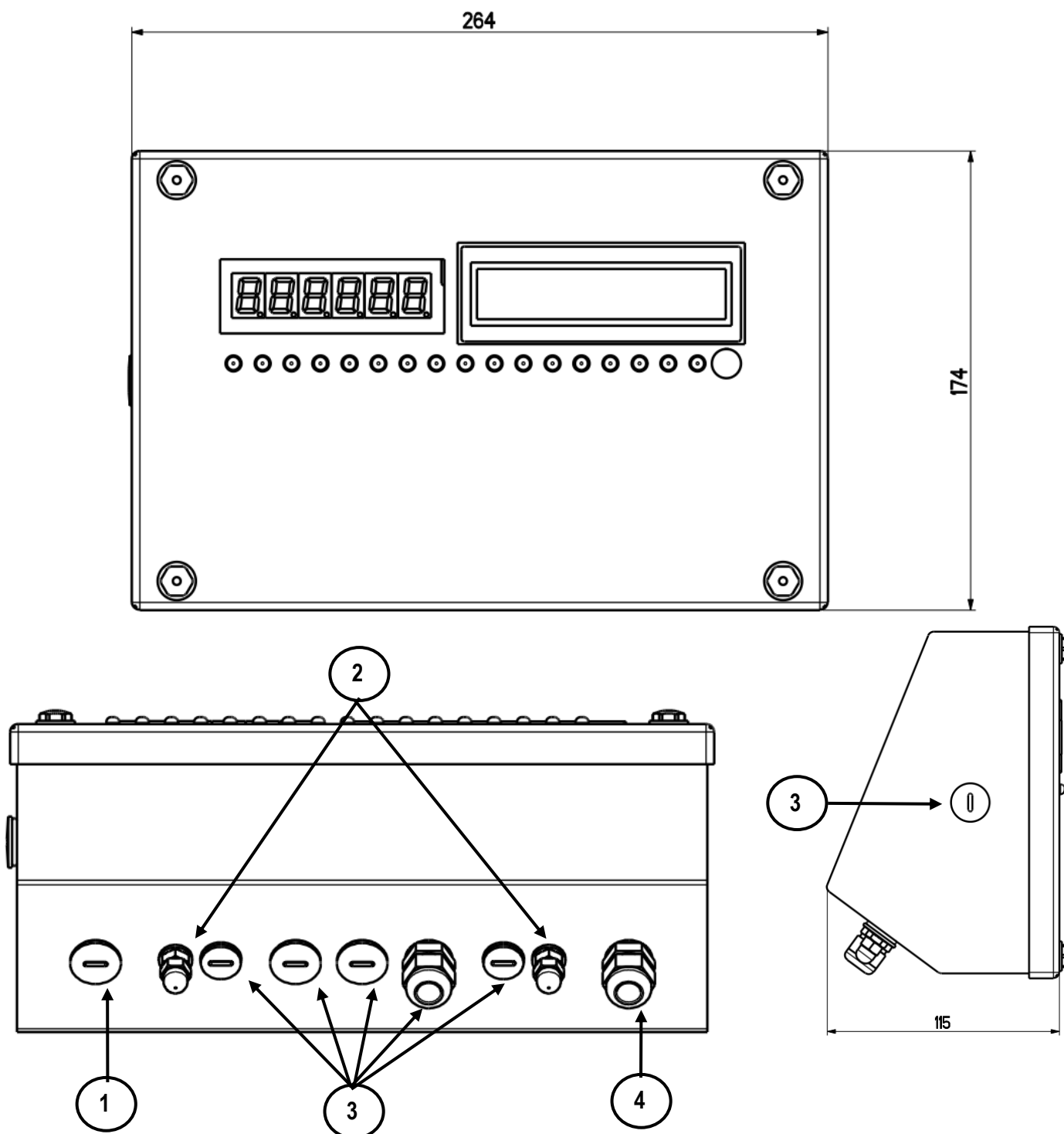

Figure 3 – Measurements and dimensions in mm

- 1) RJ11 connector
- 2) Fixing for shelf or column mounting
- 3) Available for load cells / serial lines / inputs / outputs.
- 4) Power supply input.

3.3 CPWET CASE AND DIMENSIONS

The weight indicator has a STAINLESS STEEL case, whose external dimensions are shown in figure 4. The instrument may be installed on the wall.

NOTE: If the identification plate is supplied separately (therefore not attached to the indicator), it is advisable to attach it to the indicator, in order to be able to identify the instrument.

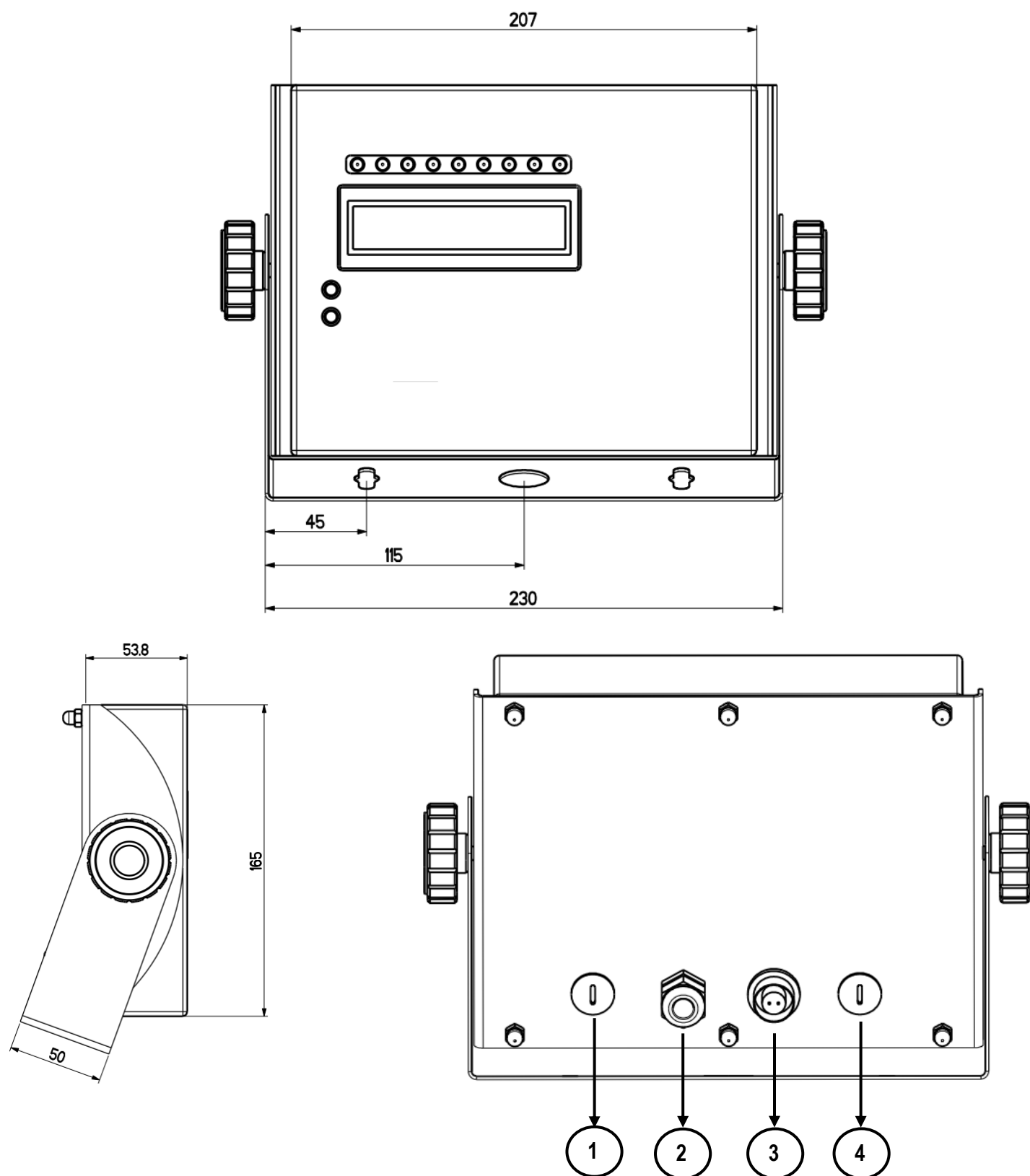

Figure 4 – Measurements and dimensions in mm

1/2) Available for load cells / serial lines / inputs / outputs

3) Power supply input.

4) RJ11 connector

3.4 CPWETD CASE AND DIMENSIONS

The weight indicator has a STAINLESS STEEL case, whose external dimensions are shown in figure 5. The instrument may be installed on the wall.

NOTE: If the identification plate is supplied separately (therefore not attached to the indicator), it is advisable to attach it to the indicator, in order to be able to identify the instrument.

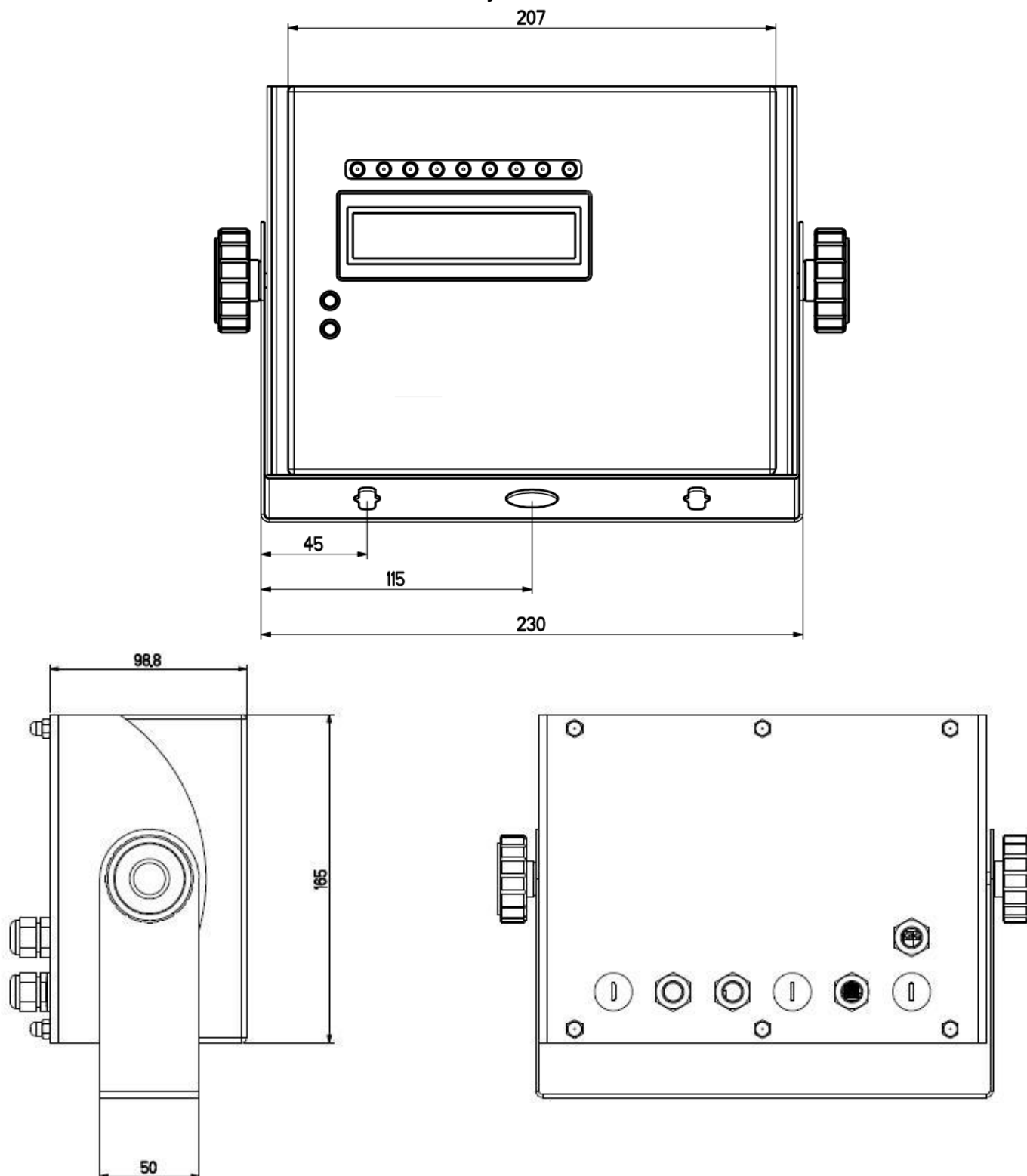

Figure 5 – Measurements and dimensions in mm

- 1/2) Available for load cells / serial lines / inputs / outputs
- 3) Power supply input.
- 4) RJ11 connector

3.5 POWER SUPPLY & START UP

- The 3590E indicator is powered with 12Vdc voltage (8 ÷ 24 Vdc in the IO version), through an internal adapter which converts the 100 ÷ 240Vac, 50÷60Hz mains voltage, and 6 Vdc, from the battery (fitted depending on the model).

TO POWER the instrument through the 240 Vac mains, or **TO RECHARGE** the battery, insert the plug and the adapter to the 240 Vac mains socket.

- The CPWE indicator is powered with 8÷24 Vdc voltage or with 6 Vdc external battery (upon request).

- The CPWET indicator is powered with 12 Vdc voltage or with 6 Vdc external battery (upon request).

To connect the indicator to the power mains, the safety regulations must be observed, including the use of a "clean" line without disturbances or interference caused by other electronic equipment.

Version with rechargeable battery: The battery inside the indicator lasts about 25 hours (without the expansion board, with 1-cell platform) and it needs a recharging time of about 12 hours.

BATTERY FEATURES

Material	LEAD
Power	4,5 Ah
Voltage	6 V

THE BATTERY MUST BE SUPPLIED DIRECTLY FROM THE MANUFACTURER.

NOTE: *it is advisable to completely recharge it (12 hours) in the first installation of the instrument; we RECOMMEND disconnecting the battery if the instrument is not going to be used for more than 30 days.*

Do not connect other equipment to the same socket as the one that the adapter is in.

Do not step on or crush the power supply cable

3.6 START UP

TO TURN ON The 3590E/CPWET press the C key until the display turns on; then release.

- The CPWE instead is automatically turned on as soon as it is powered.

The LCD display shows:

- Initially a welcome message (settable in the TECHNICAL SET-UP, << LoGo >> StEP, **TECH.MAN.REF**) while the instrument carries out a series of checking and preheating self tests.

- E-AF01 - XX" name of the installed software, in which XX identifies the software language.

- XX.YY is the software version installed.

- "EXECUTION AUTOZERO"

The instrument carries out the "autozero at start-up" function: if a weight is detected within the percentile set in the << **Auto-0** >> step (**TECH.MAN.REF.**), it is cleared; if the weight is not within this tolerance:

- with a non approved instrument, the display shows the weight after a few instants,

- with an approved instrument, the message "EXECUTION AUTOZERO" appears continuously on the display, until the weight is within tolerance.

The auto zero function at start-up may be disabled in the set-up environment (only with non approved instrument); see **SEtuP >> ConFIG >> PArAm. >> Auto-0 (TECH.MAN.REF.)**

By pressing the **2ndF** key for an instant while the version is shown in the display, the indicator will show in this order:

01.01 in which 01 indicates the instrument type, 01 indicates the metrological software version.

XX.YY.ZZ is the installed software version.

HH is the installed hardware version (08).

LEGAL FOR TRADE or HIGH RESOLUTION if the instrument is APPROVED or UNAPPROVED, respectively.

9.XXXXX is the g gravity value (only with APPROVED instrument).

3.7 TURNING OFF THE INSTRUMENT

TO TURN OFF the 3590E/CPWET or **TO RESTART** the CPWE keep the C key pressed until the "- OFF -" message appears on the LED display and " *** POWER OFF *** " on the LCD display.

TO TURN OFF the CPWE remove the instrument's power supply

3.8 TURNING ON PRINTER IN ENERGY SAVING MODE

Premise: the **SEtuP >> SEriAL >> CoMPrn >> PWrPrn** parameter must be set as **“Ext.oFF”** or **“PWrnt”**, **TECH.MAN.REF**).

In a system where the indicator is connected to a printer, both are battery powered, the printer is normally maintained in STAND-BY and powered only when a printout is needed. This function reduces the energy absorbed by the battery when the printer is not being used.

If, in this configuration, one should power the printer to change the paper and other maintenance jobs, one needs to press in sequence the **ENTER** and **0** keys during the weighing: the display shows **Prn – on** (Blinking), and the printer is kept on. Press any key to exit from this condition.

4. FRONT PANEL KEYS AND DISPLAYS

3590E



3590ED



CPWE



CPWET



4.1 FUNCTION OF THE KEYS

In the following section, and later on in the manual, the keys' functioning is described in accordance to how these are configured by factory.

It is possible to customise the functionality of the keys through the << **F.KEYS** >> step.

C/DEL	<ul style="list-style-type: none"> - Turns the instrument on/off - If pressed for an instant, it clears the tare value. - Exits the parameter without confirming and saving the modifications. - In the numeric input phase, it quickly clears the present value
TARE/ ZERO	<ul style="list-style-type: none"> - If pressed for an instant it carries out the semiautomatic tare, or cancels the tare value if the gross weight is 0. - If pressed at length, it clears the displayed gross weight, if it's within the percentage configured in the << 0.PErC >> step.
Fn/ENTER	<ul style="list-style-type: none"> - In the alphanumeric input phase, it confirms the entry made. - In the menu it allows to enter a step or to confirm a parameter inside a step.
2nd F	<ul style="list-style-type: none"> - In the << F.Keys >> step, if pressed for an instant, the list of the available functions appear and it is possible to choose one of them. - If pressed together with the other keys, it allows carrying out a specific function. (see section 4.1.1) - "2ndF" KEY: SECOND FUNCTION OF THE KEYS.
./HELP	<ul style="list-style-type: none"> - In the calculator mode or when edits printer format, if pressed, the display shows some help descriptions. - In the numeric or alphanumeric input phase, it enters, in this order, the following characters: . , ; : # < > \ " ' % & / () = ? ^ ' [] { }; - HELP function, see section 4.1.4. - If pressed in some steps or functions of the weight indicator, the display shows the keys and their functions specific to that state of the instrument.
F1	<ul style="list-style-type: none"> - By entering a number through the numerical keyboard and then pressing the F1 key, one can quickly select the article corresponding to the entered value (the article must have already been edited). - In the numeric or alphanumeric input phase, it allows to copy entered characters. - If pressed for an instant, it enters into the article database. - If pressed at length, it locks and unlocks the instrument's keyboard (except the C key).
F2	<ul style="list-style-type: none"> - In the numeric or alphanumeric input phase, it allows to stick with copied characters. - If pressed for an instant, it enters into the customer database. - If pressed at length, the weight visualisation function with sensitivity x 10 is enabled
F3	<ul style="list-style-type: none"> - If pressed for an instant, it allows to manage the set point configuration. - If pressed at length, one can adjust the date and time of the instrument.
F4	<ul style="list-style-type: none"> - If pressed for an instant, it allows to fill in the free texts, if configured - If pressed at length, it enters the instrument's diagnostics menu.
F5	<ul style="list-style-type: none"> - If pressed at length, it locks/unlocks the tare. - Commands the data transmission to the printer serial port.
F6	<ul style="list-style-type: none"> - If pressed for an instant, it carries out the totalisation. - In the numeric or alphanumeric phase, it decreases the blinking digit. - It allows scrolling ahead inside the menu steps or in the parameters within a step.
F7	<ul style="list-style-type: none"> - In the numeric or alphanumeric input phase, it increases the blinking digit. - It allows scrolling backwards in the menu steps or in the parameters within a step.
F8	<ul style="list-style-type: none"> - If pressed for an instant, it executes the printing and the zeroing of the partial total. - In the numeric or alphanumeric input phase, it selects the digit to be modified from right to left.
F9	<ul style="list-style-type: none"> - If pressed for an instant, it executes the printing and the zeroing of the general total. - In the numeric or alphanumeric input phase, it selects the digit to be modified from left to right.
F10	<ul style="list-style-type: none"> - If pressed for an instant, it executes the printing and the zeroing of the large total. - In the numeric or alphanumeric input phase, it enters a space between two characters. - In the article database, if pressed for an instant, it allows to update APW.

NUMERIC KEYBOARD	Entry of digits or characters. - During weighing, these enter a numeric value with which it's possible to: 1) Set the tare value, by pressing subsequently the TARE key (see section 7.2). 2) Sum, subtract, or multiply the value entered from the keyboard to the current tare (see the 15.2 CALCULATOR section).
3590ED	
F9	- Change the intensity of the brightness of the LED display (from 1 to 10)
F10	- Change the color of the LED display (in sequence: red, green, yellow, blue, purple, orange, white)

4.1.1 "2ndF" KEY: SECOND FUNCTION OF THE KEYS

In the weighing phase, by pressing the **2ndF** key together with another key, it's possible to execute various functions (continue reading the manual for the details of the functions):

2ndF	F1	Print/Clearing of Total of each handled Article
2ndF	F5	Repetition of the last printout made.
2ndF	F8	Net/Gross Conversion ¹
2ndF	F9	Modification of what is viewed on the display
2ndF	TARE/ZERO	Cyclical scale zero on the connected scales
2ndF	C	Causes the display of the present metric scale information (see section 9).
2ndF	0	Selection of remote scale
2ndF	1	Selection of scale 1
2ndF	2	Selection of scale 2
2ndF	3	Selection of scale 3
2ndF	4	Selection of scale 4

¹ In case of APPROVED instrument and active tare, the gross weight will show for about 5 seconds, then return to the net weight visualization.

4.1.2 ENTERING ALPHANUMERIC TEXT

It might be necessary, while the weighing system is working, to enter some alphanumerical texts such as descriptions, alphanumerical messages (operator, lot number, customer, etc.).

To enter the characters one uses the **0** to **9** keys.

By pressing one of these keys a few times, the characters shown on the key (and other special characters) will be shown on the LCD display: initially the first letter in the bottom left will appear, and then the other characters towards the right. After digiting a character, the blinking cursor, after a few instants, advances automatically of a position.

KEYBOARD	KEY OR FUNCTION EMULATE
F5	switches the writing mode from “numeric” (nuM) to “characters” (ChAr). In the nuM mode one enters <u>just the numbers</u> , while in the ChAr mode one can enter <u>all the characters of a key</u> .
C	If pressed for an instant, it cancels the written characters: first the characters that follow the cursor are cancelled; then those that precede it, one at a time. If pressed at length, it deletes all entered characters. With empty text, it exits the entry phase without confirming.
SHIFT	It enters a space in the middle of a text.
./HELP	If pressed a few times it allows entering the following characters: . , ; : # < > \ ” % & / () = ? ^ ' [] { } .
0	In “characters” mode (ChAr), by pressing once a space is entered ; by pressing twice it enters the “0” character.
1	In “characters” mode (ChAr), it pressed repeatedly, it allows to enter the following symbols: ? ! 1 @ ' + - * / = ~ € „ ... † ‡ ^ % ¨ š < OE ž ' “ ” • – – ~ ™ Š > oe ž ç £ ¤ ¥ § ¨ © ª « ¬ - ® ¯ ° ± ² ³ ´ μ ¶ · ¸ , ¹ º » ¼ ½ ¾ ¿ ã.
◀ ▶	Moves the blinking cursor to the left or to the right.
▲ ▼	Scrolls in one sense or the other the list of all the enterable characters (0, 1...9, A, B...Y, Z)

Examples:

- To enter the letter “B” one should press the “2” key twice in the **ChAr** mode.
- To enter the number “3” one should press the “3” key four times (in the **ChAr** mode) or press the F5 key (one passes to the **nuM** mode) and press the “3” key once.

4.1.3 DISABLING THE KEYBOARD

It is possible to disable all the keyboard functions (except the **C** key for turning on and off), in order to avoid undesired pressings of the scale keys:

- **To lock the keyboard**, press at length the **F1** key: the display shows the “LoCK” message for a few instants. Now the keyboard is LOCKED: if one presses a key, the display shows for a few instants the “HOLD F1 TO UNLOCK” message.
- **To unlock the keyboard**, press again at length, the **F1** key: the display shows the “unLoCk” message for a few instants.

NOTE: It’s possible to lock all keys individually in a permanent way through the TECHNICAL SET-UP, **TECH.MAN.REF.**

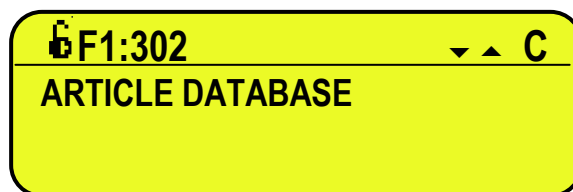

4.1.4 HELP MENU

By pressing at length the **HELP** key it is possible to access a menu containing the list of keys with the relative function, and status (locked or unlocked) indication.



The display shows:

- in the upper part: the key, followed by the code of the linked function in the << F.Keys >> step, and a symbol

indicating whether the key is unlocked () or locked () in the << EN.KEYS >> step.

- in the lower part: the description of the linked function.

Scroll the list with the arrow keys   , press the **C** key to exit.

4.1.5 INDICATOR CONNECTED TO PC KEYBOARD

It's possible to connect a PC keyboard (optional), used to emulate the functions of the keys of the indicator keys.

The keys are managed in the following way:

KEYBOARD	KEY OR FUNCTION EMULATE
Esc	- C key. - If pressed at start-up, it allows entering in the technical set-up. -In the alphanumeric input, it deletes all entered characters.
← and Canc	- C key. - If pressed at start-up, it allows entering in the technical set-up. -In the alphanumeric input, it cancels first the characters which follow the cursor, then the ones which precede it, one at a time.
Enter ↵	- Fn key. - Confirms the entered value. - Enters the displayed step
Numeric and alphanumeric keys, SHIFT and CAPS LOCK	- Quick entry of a numeric and alphanumeric string: through the CAPS/LOCK or SHIFT key it is possible to switch from the capital letters to the lower case letters, and vice versa, or enter the second character corresponding to the key (for example " , % , & , / , ?)
Cursor keys ↑ ↓	- Scroll the parameters - Increase or decrease the blinking digit while entering a value.
Cursor keys ← →	- When entering a value or an alphanumeric string, it scrolls the digits to the right or to the left.
F1, F2....F10	F1,F2....F10 keys.
F11	2ndF key
F12	TARE key.

NOTE: through the remote keyboard, it's not possible to carry out the functions made by pressing the keys at length.

4.1.5.1 DIRECT COMPILATION OF INPUT TEXT

By entering an alphanumeric text through an external keyboard the instrument goes into insertion mode; by pressing a function key from F1 to F9, programmed with a direct function to fill in an input text (121 up to 130) the edited alphanumeric text is assigned to the corresponding input text.

The alphanumeric display contains up to 32 characters.

4.1.6 REMOTE CONTROL

Depending on the indicator model, it is possible to remotely control the instrument through one of the following types of remote controls: 19-key infrared (ir) or 6-key radio (rd).

The type of remote control to be used must be selected in the Setup environment, in the << inF.Red >> step (TECH.MAN.REF).

NOTE: The infrared remote controls are for indoor use only.

4.1.6.1 "19-KEY" INFRARED REMOTE CONTROL

With this type of remote control, the functioning of the keys will be as described in the following table.

FUNCTION OF THE KEYS



KEYBOARD	KEY OR FUNCTION EMULATED
F1...F3	F1...F3 keys
C	C key
NUMERIC KEYS	Entry of digits
TARE / ▲	Tare/zero function or increase of a digit while entering a value
.	./HELP key
ZERO / ▼	Decrease of a digit while entering a value
MODE / →	Scrolls the digits to the right while entering a value
PRINT / ↵	Confirms the entered value or enters the displayed step

4.1.6.2 "6-KEY" RADIO REMOTE CONTROL

With this type of remote control, the functioning of each key can be programmed so that it is matched to one of the available keys of the indicator.

This configuration must be carried out in the Setup environment, in the << inF.Red >> step (**TECH.MAN.REF**), after the selection of this type of remote control.

By pressing the **.HELP** key of the indicator, it's possible to see, while weighing, the list of the functions matched to the keys of the indicator and also to the keys of the remote control (see section 4.1.4).

EXAMPLE OF CONFIGURATION

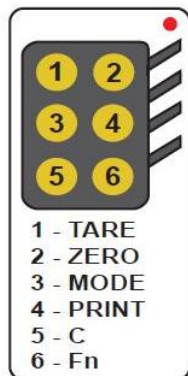

USE OF VARIOUS REMOTE CONTROLS WITH ONLY ONE INDICATOR

If one works with only an indicator, it is possible to use any 6-key remote control, without combining it to the indicator, therefore without limiting the number of usable remote controls.

To enable this mode one has to first select "RD 6 BR" in the << inF.Red >> (**TECH.MAN.REF**).

USE OF VARIOUS REMOTE CONTROLS WITH SEVERAL INDICATORS IN THE SAME AREA

If one needs to use several indicators in the same area, it is possible to combine each remote control to the desired indicator, in order to execute the function only on it and therefore avoid emulating the function on all indicators in use.

By enabling this mode it will be possible to combine up to 3 different remote controls (e.i. for 3 different operators) for each indicator.

To enable this mode one has to first select "RD 6" in the << inF.Red >> (**TECH.MAN.REF**).

To link a new remote control to the indicator one has to:

- press at length **1** and **2** keys together (3 seconds).
- the instrument displays "aut.rd?"
- press the **ENTER** key of the indicator
- the new remote control is linked

To remove the linking of a remote control one has to:

- press at length **1** and **2** keys together (3 seconds).
- the instrument displays "aut.rd?"
- press the **C** key of the indicator; if the remote control was previously linked, it will be removed.

4.2 FUNCTION DISPLAY

During the weighing the displays are subdivided mainly in 3 sections, shown in the figure below:

- 1) WEIGHT
- 2) STATUS INDICATORS (led pilot lights / or graphic symbols)
- 3) DATA (two lines in the 3590E; one or two lines in the CPWE/CPWET, depending on the weight zoom function, see following section).

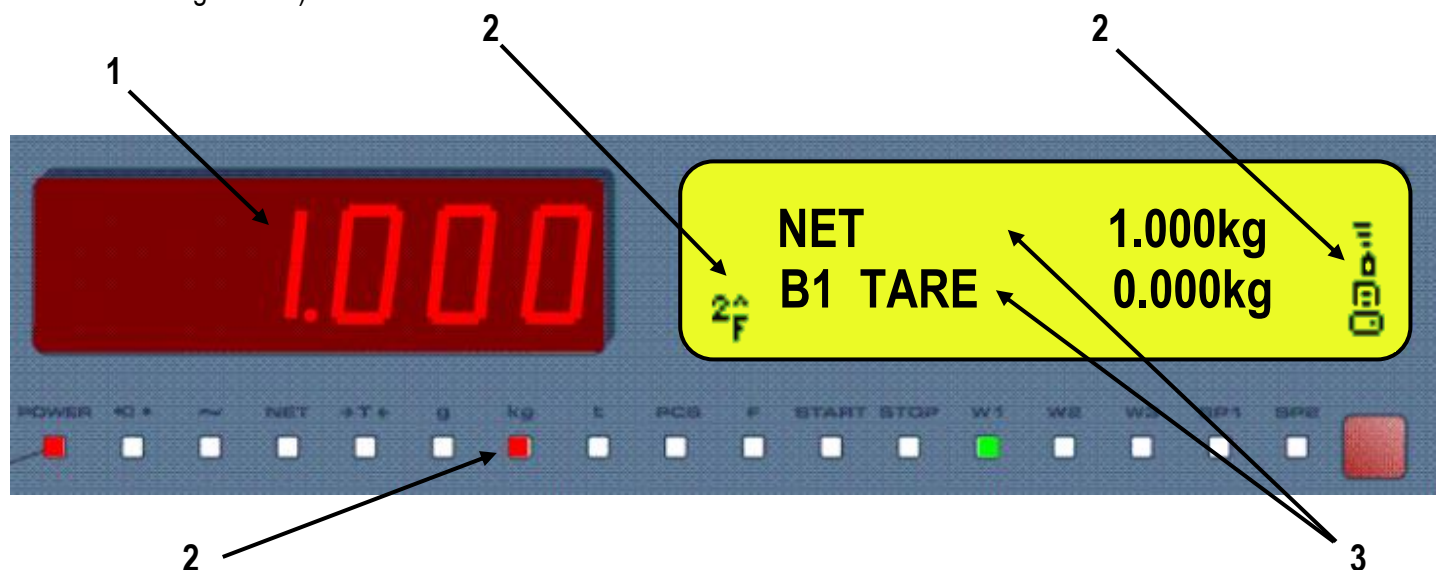

Figure 1: 3590E displays

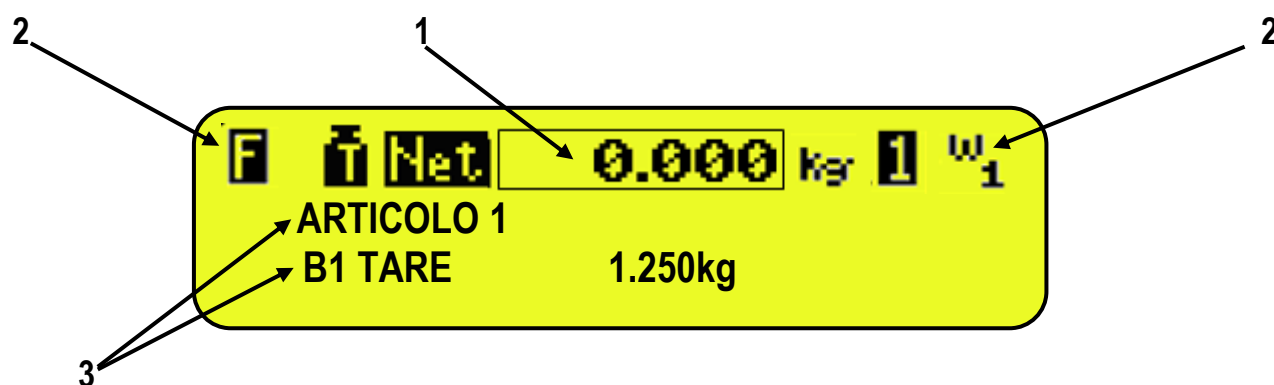
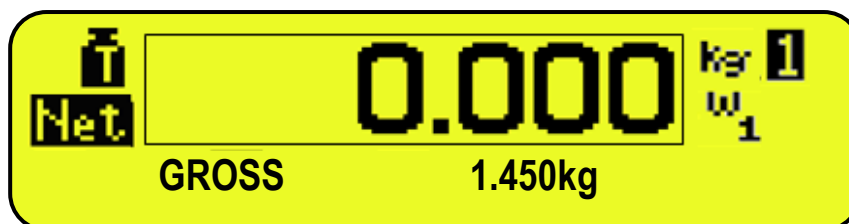

Figure 2: CPWE/CPWET display

NOTE: If the EEEEE message appears, this means that the value exceeds the maximum number of digits shown by the instrument.

4.2.1 WEIGHT ZOOM

The zoom function allows to increase the size of the weight digits, in order to ease the reading from a distance; with the active zoom, the data is shown on a single line.















Through the << ZOOM.W >> step, one can disable/enable the function and set a delay which determines the activation mode:











- always active function (with delay equal to 0), or
- disabled function at the pressing of a key and reenabled automatically when the keyboard inactivity time reaches the configured delay period (with delay greater than 0).

4.2.2 STATUS INDICATORS

LED	FUNCTION
POWER	Indicates the type of indicator power supply: - red pilot light: through built-in power adapter; - green pilot light: through battery (charged battery); - pilot light off: through battery (discharged battery).
→0←	Indicates that the weight detected by the weighing system is near zero, including the interval of $1/4 + 1/4$ of the scale's division.
~	Indicates that the weight is unstable.
NET	Indicates that the weight shown by the display is a NET WEIGHT.
→T←	Indicates that a tare value has been acquired or entered.
g	Indicates that the unit of measure in use is the gram.
kg	Indicates that the unit of measure in use is the kilogram.
t	Indicates that the unit of measure in use is the ton.
PCS	Not used in this application
F	Indicates that the unit of measure in use is the pounds.
START	Not used in this application
STOP	Not used in this application
W1 W2 W3	See section 8.
SP1	Not used in this application
SP2	Not used in this application

4.2.3 SYMBOLS SHOWN ON THE LCD DISPLAY



SYMBOL	FUNCTION
	The weight detected by the weighing system is near the zero, included within the interval of $-1/4$ and $+1/4$ of the scale division.
	The weight is unstable.
	The displayed weight is a GROSS WEIGHT (depending on the software language).
	The displayed weight is a NET WEIGHT.
	A tare value has been acquired.
	A manual tare value has been entered.
	Unit of measure in use: ton, kilogram, gram, pounds, millilitres, or millivolts.
	Active weighing range, see section 8.
	Active scale (see section 5).
	Indicates that a specific function of the instrument is active.
	Battery charge level: see section 4.2.2.
	Status output, respectively non active and active. Icon viewable only with active DIAGNOSTICS PERIPHERAL UNITS function, see section 15.1.

	Status input, respectively non active and active. Icon viewable only with active DIAGNOSTICS PERIPHERAL UNITS function, see section 15.1.
	Serial communication status with external device. Icon viewable only with active DIAGNOSTICS PERIPHERAL UNITS function, see section 15.1.
	Active during the configuration of the date and time.
	Locked keyboard, see section 4.1.3
	In the HELP menu these respectively indicate whether a key is unlocked or locked in the SETUP level (<< En.KEYS >> step, see section 4.1.4.
	The Fn key has been pressed.
	The 2nd F key has been pressed.
	Transmission of the data to the printer serial port under way.
	Inside the step, these respectively indicate an unselected or selected parameter.
	Active calculator function, see section 15.2 CALCULATOR.





4.2.3 BATTERY LEVEL INDICATION

The indicator is able to recognise whether it is powered by mains or by battery, and indicate its charge level; to enable the battery level indication, one should configure the << bt.LEVEL >> step.

The charge level is shown during weighing by the battery symbol.

- : charged battery.
- : partially charged battery.
- : discharged battery: connect the indicator to the mains for recharging the battery (if provided by that model) or replacing the battery.

The indicator shows also when the battery is being recharged (if provided for the model):

RECHARGE PHASE:  →  →  →  →  ...

COMPLETED RECHARGE: 

NOTES:

- During the recharge the instrument can be normally used.
- The instrument automatically turns off when the voltage goes below the minimum level.

4.2.4 "TILT" DEVICE

The TILT is a device which inhibits the indicator's weighing system and starts working when the instrument's inclination is greater than 2% for the pallet truck application or 5% for application on lift trucks.

The "tilt" message is shown on the display, alternate to the weight value.

The activation of the tilt alarm has a delay of about three seconds from the detection of the exceeding inclination.

See the electrical connection scheme (**TECH.MAN.REF.**) for the connection of the device.

4.2.5 DISPLAYED DATA

3590E

The data is displayed on two lines; by pressing in sequence the **2nd F** and **F9** keys, one scrolls in order the following visualisations:

NUM.	VISUALISATION	WITH SELECTED ARTICLE	WITHOUT SELECTED ARTICLE
0	First article description or net/gross weight. Active scale and active semiautomatic tare (PT if manual tare)	ARTICLE TEST B1 TARE 0.00 kg	NET 2.00 kg B1 TARE 0.00 kg
1	Total article weighs or weighs' general total. Active scale and active semiautomatic tare (PT if manual tare)	WEIGHS 00000001 B1 TARE 0.00 kg	WEIGHS 00000001 B1 TARE 0.00 kg
2	Article net total or general net total. Active scale and active semiautomatic tare (PT if manual tare)	TOT.A. 2.00 kg B1 TARE 0.00 kg	TOT.G. 2.00 kg B1 TARE 0.00 kg
3	First customer description. Active scale and active semiautomatic tare (PT if manual tare)	CUSTOMER TEST B1 TARE 0.00 kg	CUSTOMER TEST B1 TARE 0.00 kg
NOTE: this visualisation is available with an active customer			
4	Total customer weighs. Active scale and active semiautomatic tare (PT if manual tare)	C.WEI. 00000001 B1 TARE 0.00 kg	C.WEI. 00000001 B1 TARE 0.00 kg
NOTE: this visualisation is available with an active customer			
5	Customer net total. Active scale and active semiautomatic tare (PT if manual tare)	C.TOT. 2.00 kg B1 TARE 0.00 kg	C.TOT. 2.00 kg B1 TARE 0.00 kg
NOTE: this visualisation is available with an active customer			

By proceeding with the pressing in sequence of the **2nd F** and **F9** keys, the same visualisations will show up again with the 1st tare in the second line:

NUM.	VISUALISATION	WITH SELECTED ARTICLE	WITHOUT SELECTED ARTICLE
6	First article description or net/gross weight. Active scale and 1 st tare value (PT if manual tare)	ARTICLE TEST B1 1 [^] T. 0.00 kg	NET 2.00 kg B1 1 [^] T. 0.00 kg
7	Total article weighs or weighs' general total. Active scale and 1 st tare value (PT if manual tare)	WEIGHS 00000001 B1 1 [^] T. 0.00 kg	WEIGHS 00000001 B1 1 [^] T. 0.00 kg
8	Article net total or general net total. Active scale and 1 st tare value (PT if manual tare)	TOT.A. 2.00 kg B1 1 [^] T. 0.00 kg	TOT.G. 2.00 kg B1 1 [^] T. 0.00 kg
9	First customer description Active scale and 1 st tare value (PT if manual tare)	CUSTOMER TEST B1 1 [^] T. 0.00 kg	CUSTOMER TEST B1 1 [^] T. 0.00 kg
NOTE: this visualisation is available with an active customer			
10	Total customer weighs. Active scale and 1 st tare value (PT if manual tare)	C.WEI. 00000001 B1 1 [^] T. 0.00 kg	C.WEI. 00000001 B1 1 [^] T. 0.00 kg
NOTE: this visualisation is available with an active customer			
11	Customer net total. Active scale and 1 st tare value (PT if manual tare)	C.TOT. 2.00 kg B1 1 [^] T. 0.00 kg	C.TOT. 2.00 kg B1 1 [^] T. 0.00 kg
NOTE: this visualisation is available with an active customer			

By linking the function to a direct key, see the << **F.KEYS** >> step, it is possible to quickly recall a visualisation by typing, with the numeric keyboard, the relative number and pressing the key linked to the function.



Furthermore, by linking the number of a specific visualization to the function (preamble function in the << **F.KEYS** >> step), it is possible to select it directly with a direct key, for example F1 key to select the visualization n.1, and F2 key to select the visualization n. 2.

Notes:

- Default Visualisation: 0.
- If the EEEEE message appears, this means that the value exceeds the maximum number of digits shown by the instrument.

CPWE/CPWET**VISUALISATION WITH NON ACTIVE WEIGHT ZOOM**

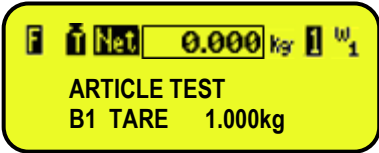
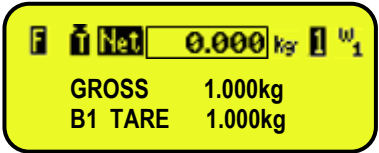
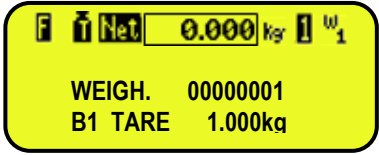
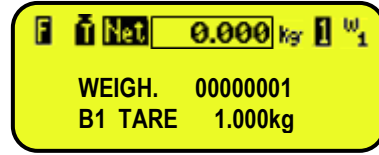
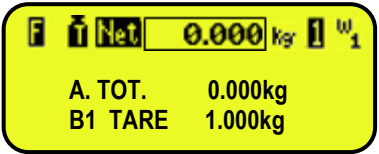
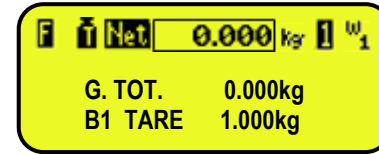
The data is shown on two lines under the "weight" section; by pressing in sequence the 2nd F and F9 keys, one scrolls in order the following visualisations:

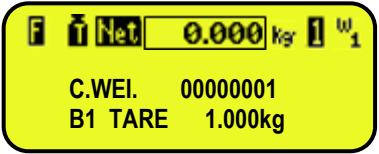
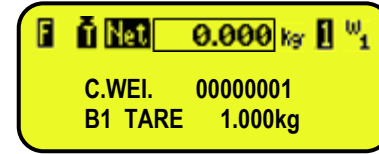
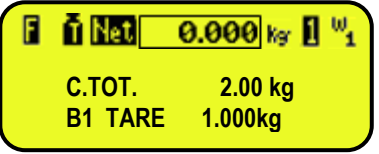
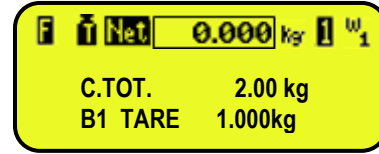
NUM.	VISUALISATION	WITH SELECTED ARTICLE	WITHOUT SELECTED ARTICLE
0	First article description or net/gross weight. Active scale and active semiautomatic tare (F if manual tare)		
1	Total article weighs or weighs' general total. Active scale and active semiautomatic tare (F if manual tare)		
2	Article net total or general net total. Active scale and active semiautomatic tare (F if manual tare)		
3	First customer description. Active scale and active semiautomatic tare (F if manual tare)		
NOTE: this visualisation is available with an active customer			
4	Total customer weighs. Active scale and active semiautomatic tare (F if manual tare)		
NOTE: this visualisation is available with an active customer			
5	Customer net total. Active scale and active semiautomatic tare (F if manual tare)		
NOTE: this visualisation is available with an active customer			

By proceeding with the pressing in sequence of the **2nd F** and **F9** keys, the same visualisations will show up again with the 1st tare in the second line:

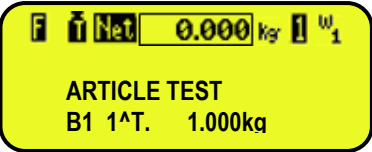
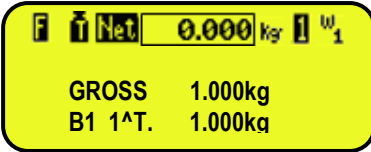
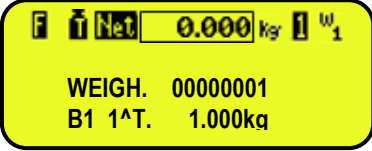
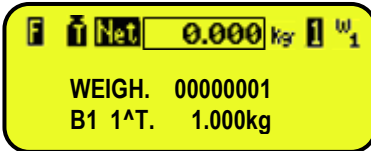
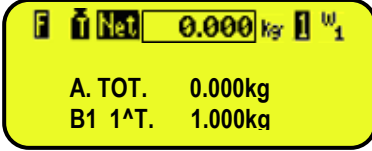
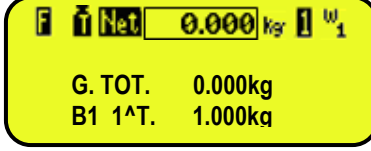
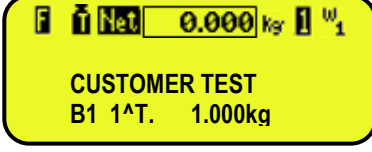
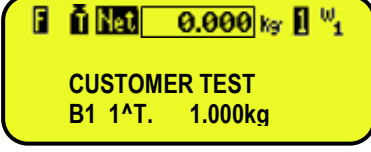
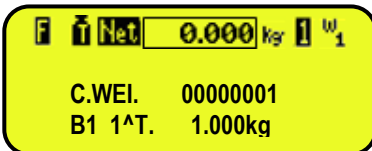
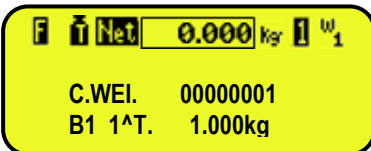
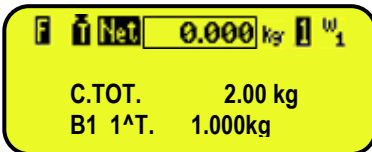
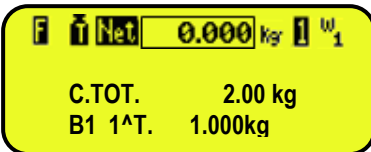
NUM.	VISUALISATION	WITH SELECTED ARTICLE	WITHOUT SELECTED ARTICLE
6	First article description or net/gross weight. Active scale and 1 st tare value (F T if manual tare)		
7	Total article weighs or weighs' general total. Active scale and 1 st tare value (F T if manual tare)		
8	Article net total or general net total. Active scale and 1 st tare value (F T if manual tare)		
9	First customer description Active scale and 1 st tare value (F T if manual tare)		
NOTE: this visualisation is available with an active customer			
10	Total customer weighs. Active scale and 1 st tare value (F T if manual tare)		
NOTE: this visualisation is available with an active customer			
11	Customer net total. Active scale and 1 st tare value (F T if manual tare)		
NOTE: this visualisation is available with an active customer			

By linking the function to a direct key, see the << **F.KEYS** >> step, it is possible to quickly recall a visualisation by digiting, with the numeric keyboard, the relative number and pressing the key linked to the function.





Furthermore, by linking the number of a specific visualization to the function (preamble function in the << **F.KEYS** >> step), it is possible to select it directly with a direct key, for example F1 key to select the visualization n.1, and F2 key to select the visualization n. 2.

Notes:

- Default Visualisation: 0.
- If the ZOOM function is always active, these visualizations will not be displayed.
- If the EEEEE message appears, this means that the value exceeds the maximum number of digits shown by the instrument.

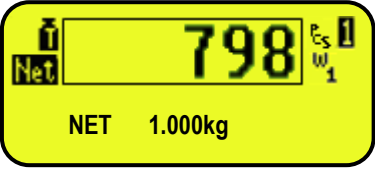
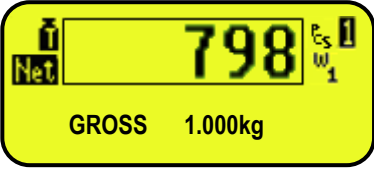
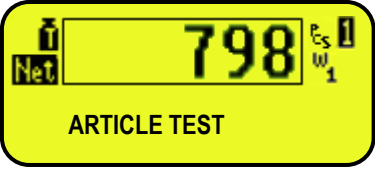
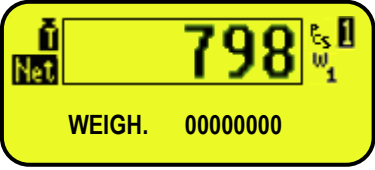
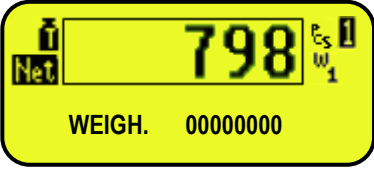
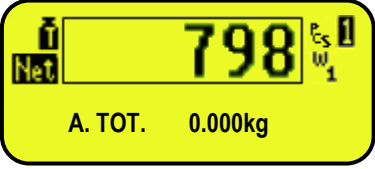
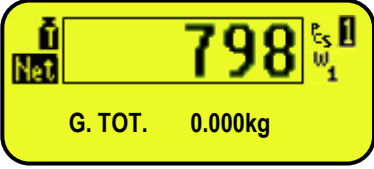
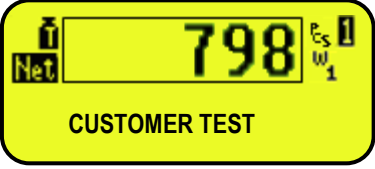
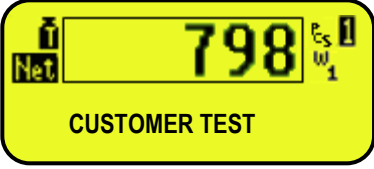
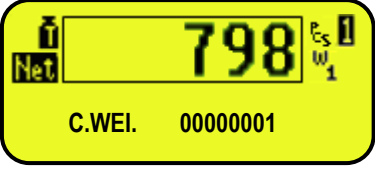
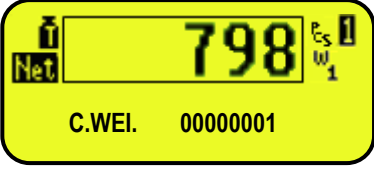
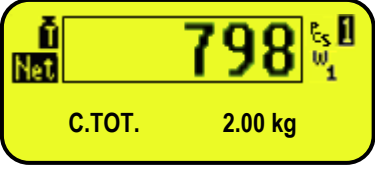
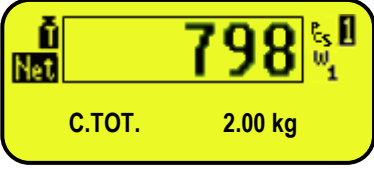
VISUALISATION WITH ACTIVE WEIGHT ZOOM

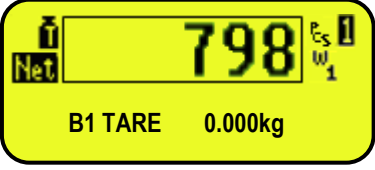
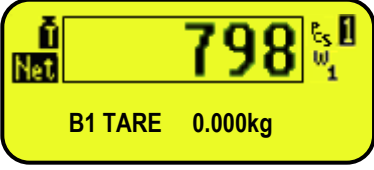
The data is shown on one line under the "weight" section. Through function **208** combinable with the desired key (<< **F.KEYS** >> step, **TECH.MAN.REF.**) one scrolls in order the following visualisations:

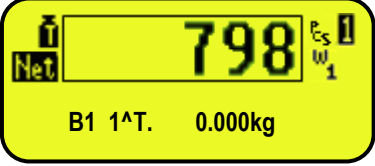
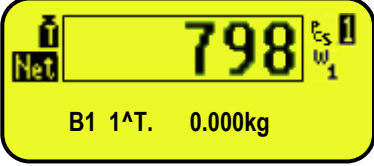
NUM.	VISUALISATION	WITH SELECTED ARTICLE	WITHOUT SELECTED ARTICLE
0	- Net/gross weight		
1	- First article description.		
2	- Total article weighs or weighs' general total.		
3	- Article net total or general net total.		
4	- First customer description		
5	- Total customer weighs.		
6	- Customer net total.		
7	- Active scale and active semiautomatic tare ( if manual tare)		
8	- Active scale and 1 st tare value ( if manual tare)		

By linking the function to a direct key, see the << **F.KEYS** >> step, it is possible to quickly recall a visualisation by digiting, with the numeric keyboard, the relative number and pressing the key linked to the function.

Furthermore, by linking the number of a specific visualization to the function (preamble function in the << **F.KEYS** >> step), it is possible to select it directly with a direct key, for example F1 key to select the visualization n.1, and F2 key to select the visualization n. 2.

NOTES

- Default Visualisation: 0.
- If the EEEEE message appears, this means that the value exceeds the maximum number of digits shown by the instrument.

5. SCALE SELECTION

If various scales are connected, in order to select these, press the **2ndF** key and then a numeric key from 0 to 4:

0 >> Scale connected to the "Com Aux" serial line.

1 >> Selection of scale number 1.

2 >> Selection of scale number 2.

3 >> Selection of scale number 3.

4 >> Selection of scale number 4.

For example with **2ndF** and the **1** key on the display, the message "SCALE 1" will appear for a few instants and then the value of the Weight on the selected scale.

In case of various connected scales, the selected scale is shown on the display of the instrument:

3590E

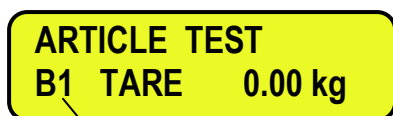

Selected scale:

B1 = scale 1; **B2** = scale 2; **B3** = scale 3; **B4** = scale 4; **R** = remote

CPWE/CPWET

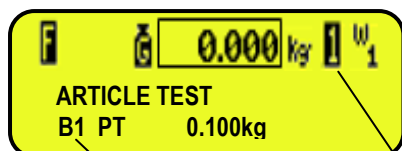

Selected scale:

B1 = scale 1; **B2** = scale 2; **B3** = scale 3; **B4** = scale 4; **B0** = remote ;
1 = scale 1; **2** = scale 2; **3** = scale 3; **4** = scale 4; **R** = remote ;



5.1 FUNCTIONING WITH REMOTE SCALE

PREMISE: the functioning of the remote scale is foreseen with the use of independent channels (**tYPE** step, **TECH.MAN.REF.**).

The remote scale transmits in a continuous mode the weight string on a dedicated serial port (optional), in a unidirectional way (from scale to indicator).

It is possible to use the serial ports on the indicator's motherboard simultaneously with the use of the remote scale.

In the normal scale status, press the **2ndF** and **0** keys to pass to the display of the weight on the remote scale.

If just the remote scale is connected, after the start-up phase, the indicator positions itself directly on it.

If the remote scale allows this, it is possible to carry out the ZERO and TARE operations directly from the indicator.

Furthermore it is possible also to carry out all the totalisation operations described in section 13, by using also the article database.

For the connection refer to the technical manual of the instrument (**TECH.MAN.REF.**).

CONFIGURATION OF THE REMOTE SCALE

See the manual of the remote scale.

CONFIGURATION OF THE INDICATOR

Refer to the technical manual for programming the indicator (**SEtuP** >> **SEriAL** >> **CoMAuX** >> **rEM.SCA** step **TECH.MAN.REF.**).

6. SCALE ZERO FUNCTION

- With various connected scales, select the scale using the numerical keyboard, using the **2ndF** and the **0**, **1**, **2** and **3** and **4** keys.

Keep the **ZERO** key pressed; the message "Zero" appears on the display after which:

- If the weight on the scale is included in the percentage configured in the << **0.PErC** >> (**RIF.MAN.T.**) step, it is zeroed;
- If the weight is not within this range, it will not be cleared and an error sound is emitted.

In the end the indicator automatically returns to the display of the weight present on the scale.

6.1 CYCLICAL AUTOMATIC ZERO

If the cyclical automatic zero has been set at the start-up (in the **SEtuP** >> **ConFig.** >> **ParaM** >> **Auto 0** step of the setup, **TECH.MAN.REF.**), by pressing the combination of the **2ndF** and **ZERO** keys, a zero cycle is executed in all the current scales.

7. TARE FUNCTIONS

7.1 SEMIAUTOMATIC TARE

By pressing the **TARE** key one tares any weight which is on the scale; the display shows "**tArE**" for an instant and then 0 (net weight); the **NET** and $\rightarrow T \leftarrow$ or \bar{t} , indicators turn on; the display shows furthermore the stored tare value. Whatever the case, a new operation automatically cancels and substitutes the previous one.

NOTES:

-The automatic tare is acquired only if the weight is of AT LEAST ONE DIVISION AND IS STABLE (\sim instability indicator is off) and VALID (In other words the OVERLOAD condition must not be created).

7.2 PRESET TARE

To enter the tare value, with the keyboard, type the desired tare value, one digit at a time; and press **TARE**. The **C** key quickly clears the typed value.

The indicator automatically subtracts the entered value from the displayed weight, (the **NET** and $\rightarrow T \leftarrow$ or \bar{t} , indicators turn on), as long as it is not greater than the instrument's maximum capacity.

The LCD display shows furthermore the stored tare value, identified with "PT" (Preset Tare).

In any case, when a new Tare value is entered, the preceding one is cancelled and substituted.

NOTE: In the printout, the manual tare is identified with "PT" (Preset Tare).

7.3 CALCULATED MANUAL TARE

With the "CALCULATOR" function one can add or subtract from the current tare the result of an operation between two values entered with the keyboard.

For the functioning specifics see the **15.2 CALCULATOR** section.

7.4 TARE DATABASE

The indicator has a database in which up to 300 prefixed tare values can be stored for each connected scale; each tare value is linked to a storage number from 0 to 299.

To access the database menus, press the **Fn** key followed by the **TARE** key, with an instrument normally turned on.

KEYS	ACCESS	KEY	MENU
Fn ENTER + TARE ZERO	Tara Database tAr.dtb t X	F1 ▶	New
		F2 ▶	Edit
		F3 ▶	Delete
		F5 ▶	Print
		Fn ▶	Select
		2nd F ▶	Deselect
		./HELP ▶	Help

NOTE: If the access password has been set in the **F.Mode** >> **dtb.PWd** "SET ACCESS PASSWORD" parameter of the SET-UP, (**TECH.MAN.REF.**), the entry, modification or cancellation of an element in a database, it is possible to only enter the password; see section 12.

7.4.1 ENTRY

- 1) Press the **Fn** key followed by the **TARE** key to enter in the tare database.
- 2) Select the eventual desired position:
 - by using the arrow keys ▲ ▼
 - with the keyboard by typing the storage number.
- 3) Press **F1** to enter the tare in the desired position, or in the first free position if an already occupied position has been selected.
- 4) The display is ready for the entry of the tare value: digit the desired value and press **ENTER** to confirm.
- 5) Restart from point 2) or press **C** to return to the weighing phase.

7.4.2 MODIFICATION

- 1) Press the **Fn** key followed by the **TARE** key to enter in the tare database.
- 2) Select the storage to be modified:
 - by using the arrow keys ▲ ▼
 - by typing the storage number with the keyboard (the display shows the first corresponding DESCRIPTION line)
- 3) Press **F2**.
- 4) Select the field to be modified by using the arrow keys ▲ ▼ and press **ENTER**.
- 5) Modify the value and press **ENTER** to confirm.
- 6) Press **C**, to return to the list of storages.
- 7) Restart from point 2) to modify other storage or press **C** to return to the weighing phase.

7.4.3 CANCELLATION

- 1) Press the **Fn** key followed by the **TARE** key to enter in the tare database.
- 2) Select the storage to be deleted:
 - by using the arrow keys ▲ ▼
 - by typing the storage number with the keyboard (the LCD display shows the first corresponding DESCRIPTION line).
- 3) Press **F3**.
- 4) The indicator requests a further confirmation: press **ENTER** to confirm or another key to cancel.
- 5) Restart from point 2) or Press **C** to return to the weighing phase.

7.4.4 PRINTING

- 1) Press the **Fn** key followed by the **TARE** key to enter in the tare database.
- 2) Once inside the article database menu, press the **F5** key. The display shows the "PRINT?" text: confirm with the **ENTER** key to print the list of the stored tare values, referred to the selected scale.

7.4.5 SELECTION

To select a stored tare during the standard weighing operations, one can proceed in two ways:

- 1) Digit the storage number of the tare using the numeric keyboard and recall the **306** function, combinable with the desired key (<< **F.KEYS** >> step, **TECH.MAN.REF.**).
If a tare is stored in the recalled position, the indicator activates it.
- 2) Press the **Fn** key followed by the **TARE** key to enter in the tare database:
Select the memory storage:
 - By using the arrow keys ▲ ▼
 - by typing the storage number with the keyboard(the display shows the corresponding tare value).
- 3) Press **ENTER** to enable the tare.

**TARE XXX
SELECTED**

**DESELECT
TARE?**

7.4.6 HELP

By pressing the **/HELP** key, it's possible to see the keys list used in the menu.

The key list is automatically shown. If you want to see the keys list, in manual mode, use the arrow key (F6 ▼ e F7 ▲).

7.5 TARE CANCELLATION

To **cancel** the stored tare:

- With an **unloaded** platform, press the **TARE** key.
- With loaded platform press in sequence the numeric 0 key and **TARE**.

Press the **C** key (**CAREFUL**: this operation cancels also the executed reference).

7.6 LOCKED/UNLOCKED TARE

Normally, when there is this value, by unloading the scale plate, the display shows the tare value with a negative sign (LOCKED TARE). One can also choose that the tare value is cancelled automatically, each time that the scale is unloaded (LOCKED TARE):

CONDITIONS FOR AUTOMATIC UNLOCKING:

- In case of **SEMI-AUTOMATIC TARE**, the net weight before unloading the scale may also be 0.
- In case of **MANUAL OR CALCULATED TARE** or **FROM DATABASE**, the net weight before unloading the scale must be of at least 2 stable divisions.

If the **F5** key is pressed at length, it is possible to quickly lock/unlock the tare:

DISPLAY	MEANING
LoCK	LOCKED TARE
unLoCK	UNLOCKED TARE

The setting of the tare may be made also in the "TARE LOCK/UNLOCK" **SEtuP >> t.LoCK** parameter of the TECHNICAL SETUP, **TECH.MAN.REF.**

7.7 LIMITATION OF THE TARE FUNCTIONS

For specific requirements, it is possible to limit the tare functions **with approved instrument**; by setting "YES" in the **SEtuP >> d.SALE** step of the SET-UP environment (**TECH.MAN.REF.**):

- the SEMIAUTOMATIC TARE can not be modified with a manual or calculated tare, or one from database.
- the manual or calculated tare, or one from database must be entered or modified only with UNLOADED scale.

With approved instrument, the **SEtuP >> d.SALE** step is not displayed. Read only.

7.8 LINKING OF A PRESET TARE WITH AN ARTICLE IN THE DATABASE.

It is possible to link a known tare value stored in the tare database to each article in the database; this value will be enabled with each selection of the article.

See section 11.1 for further details.

7.9 EXECUTION MODE / DISABLING OF THE TARE

It's possible to select the tare execution mode, through the setting of the **F.ModE >> totAL >> tArE** step (**TECH.MAN.REF.**):

- By setting "diSAbL" one disables all the tare operations;
- By setting "EnAbLE" one enables all the tare operations described previously.
- By setting "MAnd" the tare must be executed before executing a totalisation (useful for the formulations).
- By setting "A.MAnd" and putting a weight on an unloaded scale, it will automatically be tared: this will be done only if there is no tare and there is a stable gross weight of at least 5d.

7.10 AUTOMATIC TARE AFTER THE TOTALISATION

By setting "Auto" in the **F.ModE >> totAL >> t.tot** step (**TECH.MAN.REF.**) one enables the automatic execution of the tare after the totalisation, while by setting "MANuAL" the execution of the tare must be executed only by the operator.

NOTES:

The tare, both automatic and manual:

- is executed only if the tare execution is not disabled (See "SELECTION OF THE TARE EXECUTION MODE" section);
- substitutes the stored tare value, but in any case the value of the first executed tare (useful for formulation or dosage) is stored.

7.11 FIRST TARE OPERATION IN FORMULATION

In the formulation applications it's possible to store and print the first executed tare; the stored value can also be shown on the LCD display (See section 4.2.4).

7.12 RESTORING TARE AND ZERO AT THE START-UP

By setting "EnAbLE" in the **F. ModE >> rEstAr** step (**TECH.MAN.REF.**) one enables the restoring of the active tares before turning off the instrument, and, if the actual gross weight and the last gross weight stored before the instrument is turned off are higher than zero, the last stored ZERO value is set, otherwise the instrument carries out the auto-zero function.

NOTE: The tares are restored as predetermined tares.

8. MULTIRANGE AND MULTIDIVISION FUNCTION

The **multi range functioning** allows to subdivide the scale capacity in two or three ranges, each of which is up to 3000 divisions, improving in this way the first range division in the dual range and the first two ranges in the triple range.

For example it is possible to approve the weighing system with:

- A single range: 6 kg capacity and 2 g division (3000 div.).
- Dual range: 6 / 3 kg capacity and 2/1 g division (3000 + 3000 div.).
- Triple range: 15 / 6 / 3 kg capacity and 5/2/1 g division (3000 + 3000 + 3000 div.).

NOTE: For the approval of the weighing system in dual and triple range the cell must have better technical features in comparison to the cell used for the approval in a single range.

This functioning is indicated by the turning on of the indicator which identify the range in which one is working: **W1** first range, **W2** second range, **W3** third range (if configured); by passing to the **W2** range, the second range division is enabled; by passing to the **W3** range, the third range division is enabled, at this point the **W1** first scale division is restored **only by passing the gross zero of the scale**.

The **multidivisional functioning** is similar to multirange, but with the difference that a range division is enabled as soon as one enters in its range interval (in other words **without passing by the scale zero**).

NOTE: The selection of the range number with multirange and multidivisional functioning is made during the indicator calibration (**TECH.MAN.REF.**).

9. DISPLAY OF METRIC DATA (inFO)

The indicator is fitted with a function named "INFO", thanks to which it is possible to view the configuration metric data:

- First range capacity, first range minimum weigh, first range division.
- Second range capacity, second range minimum weigh, second range division.
- Third range capacity, third range minimum weigh, third range division.

NOTES:

- The data of the second and third range appear only if actually configured.

To display the metric data:

- Press in sequence the **2ndF** and **C** key
- "METROLOGIC INFORMATION" is displayed
- The display will show the number of the scale, the type of displayed data and its value.
- Press the **F6** key to quickly scroll the following data in this order:
- Press the **F7** key to quickly scroll the previous data backwards.
- Press the **C** key to quickly return to weighing.

10. FILLING IN THE INPUT TEXT

The indicator offers the possibility of using 15 CONFIGURABLE INPUT TEXTS (for example LOT, OPERATOR, SHIFT, etc.), each made up of 16 heading characters and 32 content characters.

When entered in the TECHNICAL SET-UP (see **F.ModE** >> **tXt** "Input text configuration" parameter, **TECH.MAN.REF.**), these may be printed later on, if programmed in the printouts; or these may be used as a reminder.

- Press **F4** for an instant one can enter the contents of the programmed INPUT TEXTS:
- The LCD display shows "in. XX", in the first line in which XX is the index of the free text (from 0 to 14) and THE HEADING on the second line (or "Empty..." if empty).
- Use the arrow **▲ ▼** keys to select the text to be filled in and press **ENTER**: now one can enter the alphanumeric text in the second line of the display, (see chapter 4.1.2 ENTERING ALPHANUMERIC TEXT).
- Press **ENTER** to store and pass on to the following stored TEXT; by confirming the last entered text one returns automatically to the weigh functioning; it is possible to exit also with the **C** key while in the text selection modification phase.

NOTE:

- The entered texts remain in storage until these are substituted or cancelled.
- If no text has been configured, the pressing of the **F4** key has no effect.
- Through specific print macros, it's possible to automatically cancel the contents of all the texts, right after their printing (**TECH.MAN.REF.**).
- For information on the entry of the alphanumeric texts, see section "ENTERING ALPHANUMERIC TEXT".

10.1 QUICK MODIFICATION OF AN INPUT TEXT

By linking the number of a specific input text to the function **113** (preamble function in the << **F.KEYS** >> step, **TECH.MAN.REF.**), it is possible to access directly to the modification of it with a direct key, for example **F1** key to quickly access the text 0, and **F2** key to quickly access the text 1.

11. DATABASE

11.1 ARTICLES

The indicator has a database in which it is possible to store up to 1000 articles having three descriptions of 20 characters; each article is linked to a storage number, from 0 to 999.

The selected article is shown on the display during the weighing operations, and can be printed through the relative print block.

KEYS	ACCESS	KEY	MENU
	Article Database Art.dtb A X	F1 ▶	New
		F2 ▶	Edit
		F3 ▶	Delete
		F4 ▶	Research
		F5 ▶	Print
		Fn ▶	Select
		2nd F ▶	Deselect
		. / HELP ▶	Help

11.1.1 ENTRY

1) Press the **F1** key to enter in the article database.

NOTE: we advise to leave empty the memory storage 0, since it is used for the temporary entry (see section “11.1.6 TEMPORARY ENTRY”).

2) Select the eventual desired position

- By using the arrow keys ▲ ▼
- with the keyboard by typing the storage number

3) Press **F1** to insert the article in the desired position, or with the first free position, if an already occupied position has been selected.

4) One should fill in the following fields (only the necessary ones are requested); press **ENTER** to confirm:

- "**DESCRIPTION 1**": first description line (up to 20 characters);
- "**DESCRIPTION 2**": second description line (up to 20 characters);
- "**DESCRIPTION 3**": third description line (up to 20 characters);
- "**LINKED TARE**": linking of a TARE IN THE DATABASE; the display shows the number of the tare in the database (from 0 to 299), while the display shows its value.
With the arrow keys ▲ ▼ select the available tares and press **ENTER** to confirm; by pressing instead the **C** key one passes to the following setting by cancelling the linkage to the tare.
- "**LINKED CUSTOMER**": linking of a CUSTOMER IN THE DATABASE; the display shows the customer number in the database (from 0 to 99), while the display shows its value.
Select the customer with the arrow keys ▲ ▼ and press **ENTER** to confirm; by pressing, instead, the **C** key, one passes to the following configuration, cancelling the linking to the customer.

5) Restart from point 2) or Press the **C** key to return to weighing.

11.1.2 MODIFICATION

- 1) Press the **F1** key to enter in the article database.
- 2) Select the storage to be modified:
 - by using the arrow keys ▲ ▼
 - or by typing the storage number with the keyboard (the display shows the first corresponding DESCRIPTION line).
 - by searching the first description (see section 11.1.7)
- 3) Press **F2**.
- 4) Select the field to be modified by using the arrows keys ▲ ▼ and press **ENTER**.
- 5) Modify the value and press **ENTER** to confirm.
- 6) Restart from point 4) to modify other fields, or press **C**, to return to the list.
- 7) Restart from point 2) to modify other storage or press **C** to return to the weighing phase.

11.1.3 CANCELLATION

- 1) Press the **F1** key to enter in the article database.
- 2) Select the storage to be deleted
 - by using the arrow keys ▲ ▼
 - by typing type the storage number with the keyboard;(the display shows the first corresponding DESCRIPTION line).
 - by searching the first description (see section 11.1.7)
- 3) Press **F3**.
- 4) The indicator requests a further confirmation: press **ENTER** to confirm or another key to cancel.
- 5) Restart from point 2) or press the **C** key to return to weighing.

11.1.4 PRINTING

- 1) Press the **F1** key to enter in the article database.
- 2) Once inside the article database menu, press the **F5** key. The display shows the message "**PRINT?**": confirm with the **ENTER** key to print the entire article database which shows all the relative fields for each stored article.

11.1.5 SELECTION / DESELECTION

With no memory storage selected, the display shows in the data section (see 4.2 section):

To select a stored article, one can proceed in two ways:

- 1) Press the **F1** key to access database:
- 2) Select the memory storage:
 - by using the arrow keys ▲ ▼
 - by typing the storage number with the keyboard (the LCD display shows the first corresponding DESCRIPTION line).
 - by searching the first description (see section 11.1.7)
- 3) Press **ENTER** to activate the article.

**ARTICLE XXX
SELECTED**

To unselect a selected article, for an instant press the **F1** key to enter in the article database and press **2nd F**. Before unselecting, a confirmation is requested: press **ENTER** to confirm or another key to cancel.

**DESELECT
ARTICLE?**

11.1.6 ENTRY, MODIFICATION AND QUICK SELECTION OF ARTICLE 000

It's possible to enter or modify quickly the article 000:

- Type the number 0 using the numeric keyboard and press **F1**:
the indicator is ready to enter/modify the article 000: once modified and confirmed with **ENTER**, it is also selected. **The modification has effect also in the database.**

11.1.7 ALPHABETICAL RESEARCH

The access to the ALPHABETICAL RESEARCH is possible in the following 2 ways:

- 1) by pressing the **F1** to access the database and by pressing the **F4** key;
or
- 2) through function **313** combinable with the desired key (<< **F.KEYS** >> step, **TECH.MAN.REF.**).

To search an article:

- 1) Enter the desired characters to search in the first description of all the articles.
- 2) Select the desired storage in the list of the results by using the arrow keys **▲ ▼** and press **ENTER**.
- 3) Carry out one of the operations described in the previous sections.

11.1.8 HELP

By pressing the **./HELP** key, it's possible to see the keys list used in the menu.

The key list is automatically shown. If you want to see the keys list, in manual mode, use the arrow key (**F6 ▼** and **F7 ▲**).

11.2 CUSTOMERS

The indicator is fitted with a database in which it is possible to store up to 200 customers having five descriptions of 30 characters; each customer is linked to a storage number, from 0 to 199.

The selected customer is shown on the display during the weighing operations, and can be printed through the relative printing block and linked to an article (see previous section).

KEYS	ACCESS	KEY	MENU
	Customer Database CuS.dtb C X	F1 ▶	New
		F2 ▶	Edit
		F3 ▶	Delete
		F4 ▶	Research
		F5 ▶	Print
		Fn ▶	Select
		2nd F ▶	Deselect
		./ HELP ▶	Help

11.2.1 ENTRY

- 1) Press the **F2** key to enter in the customer database.
NOTE: it is advisable to leave empty the 0 memory storage, since it is used for the temporary entry (see section "11.2.6 TEMPORARY ENTRY").
- 2) Select the desired position :
 - by using the arrow keys **▲ ▼**
 - with the keyboard the storage number
- 3) Press **F1** to enter the customer in the desired position, or in the first empty position if an already occupied position has been selected.
- 4) One should fill in the following fields (only the necessary ones are requested) by pressing **ENTER** to confirm:
 - **"TEXT 1"**: first description line (up to 30 characters);
 - **"TEXT 2"**: second description line (up to 30 characters);
 - **"TEXT 3"**: third description line (up to 30 characters);
 - **"TEXT 4"**: fourth description line (up to 30 characters);
 - **"TEXT 5"**: fifth description line (up to 30 characters);
- 5) Press the **C** key to return to the weighing phase.

11.2.2 MODIFICATION

- 1) Press the **F2** key to enter in the customer database.
- 2) Select the storage to be modified
 - by using the arrow keys ▲ ▼
 - by typing the storage number with the keyboard(the display shows the first corresponding DESCRIPTION line).
 - Search the first description (see the paragraph
- 3) Press **F2**.
- 4) Select the field to be modified by using the arrow keys ▲ ▼ and press **ENTER**.
- 5) Modify the value and press **ENTER** to confirm.
- 6) Restart from point 4) to modify other fields or press **C** to return to the list of storages.
- 7) Restart from point 2) to modify other storage or Press the **C** key to return to the weighing phase.

11.2.3 CANCELLATION

- 1) Press the **F2** key to access the database. to enter in the customer database.
- 2) Select the storage to be modified:
 - By using the arrow keys ▲ ▼
 - by typing the storage number (the display shows the first corresponding DESCRIPTION line).
- 3) Press **F3**.
- 4) The indicator requests a further confirmation: press **ENTER** to confirm or another key to cancel.
- 5) Restart from point 2) or Press the **C** key to return to the weighing.

11.2.4 PRINTING

- 1) Press **F2** to enter in the customer database.
- 2) Once inside the customer database menu press the **F5** key. The display shows the message "**PRINT?**": confirm with the **ENTER** key to print the whole customer database which shows all the relative fields for each stored customer.

11.2.5 SELECTION / DESELECTION

With no memory storage selected, the display shows in the data section (see 4.2 section):

To select a stored customer, one can proceed in two ways:

- 1) Type the memory storage number and press **F2**.
- 2) By pressing for an instant the **F2** key to enter in the customer database:
 - Select the storage using the arrow keys ▲ ▼
 - by typing the storage number(the LCD display shows the first corresponding 7DESCRIPTION line).
 - by searching the first description (see section 11.2.7)
- 3) Press **ENTER**.

**CUSTOMER XXX
SELECTED**

To unselect a selected article, for an instant press the **F1** key to enter in the article database and press **2nd F**. Before unselecting, a confirmation is requested: press **ENTER** to confirm or another key to cancel.

**DESELECT
CUSTOMER?**

11.2.6 ENTRY, MODIFICATION AND QUICK SELECTION OF CUSTOMER 000

It's possible to enter or modify quickly the customer 000:

- Type the number 0 using the numeric keyboard and press **F2**:
- The indicator is ready to enter/modify the customer 000: once modified and confirmed with **ENTER**, it is also selected.
The modification has effect also in the database.

11.2.7 ALPHABETICAL RESEARCH

The access to the ALPHABETICAL RESEARCH is possible in the following 2 ways:

- 1) by pressing the **F2** to access the database and by pressing the **F4** key;
or
- 2) through function **310** combinable with the desired key (<< **F.KEYS** >> step, **TECH.MAN.REF.**).

To search a customer:

- 1) Enter the desired characters to search in the first description of all the customers.
- 2) Select the desired storage in the list of the result by using the arrow keys **▲ ▼** and press **ENTER**.
- 3) Carry out one of the operations described in the previous sections.

11.2.8 HELP

By pressing the **./HELP** key, it's possible to see the keys list used in the menu.

The key list is automatically. If you want to see the keys list, in manual mode, use the arrow key (F6 **▼** e F7 **▲**).

12. DATABASE ACCESS PASSWORD

In the SETUP (F. Mode>> dtb.PWd parameter, TECH.MAN.REF.) one can set a password for access to the databases. A password will be required only when one wants to insert, modify or delete an element of the file; for a moment the LCD display shows the message USER-PRESS KEY; afterwards, it will be no longer possible to make changes to the database.

To access the complete menu

- Press any key DURING THE VISUALISATION OF THE "USER-PRESS KEY": the instrument requests the entry of the password (a number will appear).
- Enter the password and confirm with ENTER.

13. WEIGHT TOTALISATION FUNCTIONS

The programme has been made to manage the accumulation and the printing of the weight and quantity.

The totalisation takes place in the ways selectable in the technical set-up, described in the following section.

The totalised weight and quantity are automatically accumulated in the instrument totals (PARTIAL, GENERAL, GRAND TOTAL), and the weighs' progressives are automatically increased relative to the previously shown totals.

Furthermore, if an article has been enabled, the instrument increases both the totals as well as the weighs' progressive relative to the selected article.

The data that is increased is:

- WEIGH NUMBER
- GROSS WEIGHT TOTAL
- NET WEIGHT TOTAL
- TARE TOTAL

13.1 TOTALISATION MODES

The indicator allows to accumulate the weight on the scale in different modes:

- Totalisation in loading.
- Totalisation in unloading.
- Totalisation both in loading as well as in unloading.

The setting of the totalisation is made in the set-up environment, in the **F.ModE >> totAl >> Tot.tYP** parameter **TECH.MAN.REF.**

13.1.1 TOTALISER IN LOADING

This type of totaliser allows to totalise with a positive net weight. To do this one should:

- 1) Put the article on the scale and wait for the weight to become stable.
- 2) Press the “**F6**” key (manual totalisation), the display shows for an instant the “**totAL**” message along with an acoustic signal; the weight on the scale is accumulated in all the totals, and, if a print format has been linked, the printing will be made.
- 3) Remove the article from the scale, put another one and repeat the operation described in point 2.

13.1.2 TOTALISER IN UNLOADING

This type of totaliser allows to totalise with a negative net weight. To do this one should:

- 1) Put the articles to be unloaded on the scale and wait for the weight to become stable.
- 2) Tare the weight with the **TARE** key.
- 3) Remove the weight which you want to unload and wait for the weight to become stable (one will see a negative weight).
- 4) Press the “**F6**” key (manual totalisation): the display will show for an instant “**totAL**” along with an acoustic signal; the weight on the scale is accumulated in all the totals, and, if a print format has been linked, printout will be made.
- 5) the tare value on the display will not vary, but increases normally with the **TARE** key.
- 6) Repeat the operations from point 3.

13.1.3 TOTALISER IN LOADING AS WELL AS IN UNLOADING

This type of totaliser allows to totalised both with a positive net weight as well as with a negative net weight. See 13.1.1 and 13.1.2 section.

13.2 TOTALISATION WITH AUTOMATIC EXECUTION OF THE TARE

It is useful for formulation or dosage applications and allows to automatically tare after the accumulation of the weight on the scale (both in loading as well as in unloading, and manually as well as automatically), allowing to totalise the subsequent one on its own and without unloading the scale.

See also section 7.10.

13.3 MANUAL OR AUTOMATIC TOTALIZATION

The operation of accumulation, normally done manually with key “F1”, can be done automatically when the weight is stable. The choice of the totalisation execution mode is made in the **F.mode >> totAL >> EXE.tot** “TOTALISER FUNCTION MODE” parameter (**TECH.MAN.REF.**).

13.4 TOTALISATION DELAY

Only with the automatic totalisation is it possible to set a delay for acquiring the weigh; this delay period runs from the weight acquisition and the totalisation.

See the **F.mode >> totAL >> dLY.tot** step in the technical manual (**TECH.MAN.REF.**).

13.5 TOTALISATION FIELD

It is possible to define a weight interval (between 0 and the scale capacity) inside of which it is possible to carry out a totalisation and outside of which the totalization is not accepted. Use of the totalling field is particularly useful when totalling is done automatically with the weight stable.

SETTING THE TOTALISATION THRESHOLDS:

- Through the **500** function, combinable with the desired key (<< **F.KEYS** >> step, **TECH.MAN.REF.**), it’s possible to access the “thr.hi” menu (Maximum Threshold Setting): set the upper totalisation threshold and press **ENTER**.
- Through the **501** function, combinable with the desired key (<< **F.KEYS** >> step, **TECH.MAN.REF.**), it’s possible to access the “thr.Lo” menu (Minimum Threshold Setting): set the lower totalisation threshold and press **ENTER**.

NOTES:

- By setting 0 in the maximum threshold, it’s possible to totalise up to the maximum capacity of the scale.
- By setting 0 in both thresholds, the functions are disabled.
- The totalisation field is valid for all totalisation types (in loading, in unloading, and in loading as well as in unloading).

13.6 CONDITIONS FOR TOTALISATION

With APPROVED instrument:

- The MANUAL and AUTOMATIC totalisation works with a POSITIVE NET WEIGHT (in LOADING) or a NEGATIVE NET WEIGHT (in UNLOADING).
- The totalisation is reenabled depending on how the **F.mode >> rEACt** parameter has been programmed in the TECHNICAL SET-UP (**TECH.MAN.REF.**).
- The totalisation excludes the simple printout and viceversa.

With NON APPROVED instrument:

- The MANUAL totalisation works with a NET WEIGHT greater than zero (in LOADING) or a NET WEIGHT lower than zero (in UNLOADING).
- The AUTOMATIC totalisation works with a minimum POSITIVE NET WEIGHT of at least 10 divisions (in LOADING) or a NEGATIVE NET WEIGHT of at least 10 divisions (in UNLOADING).
- The totalisation is reenabled depending on how the **F.mode >> rEACt** parameter has been programmed in the TECHNICAL SET-UP (**TECH.MAN.REF.**).
- The totalisation does not exclude the simple printout.

13.7 PRINT REENABLING AND TOTALISATION

When the indicator is used, it is possible to incur in the "WEIGHT NOT PASSED BY 0 OR INSTABILITY" error shown on the LCD display; this means that the function which one wants to execute must be reenabled (in order to avoid accidental executions).

It is possible to set the reenabling of the function in the following modes: "passage by net zero of the weight", "reenabling upon weight instability" or "always enable".

See the **F.ModE >> rEACt** parameter of the set-up parameter (**TECH.MAN.REF.**).

13.8 VISUALISATION AND CLEARING OF THE ACCUMULATED TOTALS

Each total can be momentarily viewed on the display or cleared independently through the printout, linking the function corresponding to the desired step (<< **F.KEYS** >> step, **TECH.MAN.REF.**):

TOTAL	FUNCTION CODE FOR VISUALIZATION	FUNCTION CODE FOR RESETTING
PARTIAL TOTAL	406	408
GENERAL TOTAL	409	411
GRAND TOTAL	412	414
ARTICLE TOTAL (only with selected article)	415	417
CUSTOMER TOTAL (only with selected customer)	421	423
LIST SAMPLES	-	312
ALL TOTAL SCALE (including weighs' lists, except the article total)	-	418
ALL TOTAL ARTICLE	-	419
ALL TOTAL CUSTOMER	-	424

By recalling one of the clearing functions, the instrument requests a confirmation before proceeding with the cancellation: press **ENTER** to clear, **C** for continuing to accumulate.

It's possible to disable the confirmation request, in the **F.ModE >> totAL >> rESEt** step, **TECH.MAN.REF.**

In case of visualisation of the total, the instrument automatically exits the function after a few seconds.

NOTES:

- The clearing of the weight total causes also the reset of the relative number of weighs.
- The weight data of the cleared total will be updated only with the subsequent totalisation.
- The ARTICLE TOTAL is article specific, in other words, there is a total for EACH ARTICLE USED.

The other totals are GENERIC, and can be cleared INDEPENDENTLY ONE FROM THE OTHER (i.e. if one clears the Grand total, with the following totalisation, the other totals will continue to increment, while the Grand total will restart from 0).

13.9 CLEARING AND AUTOMATIC PRINTING OF THE PARTIAL TOTAL AFTER N WEIGHS

Through the function **400** (combinable with the desired key, << **F.KEYS** >> step, **TECH.MAN.REF.**), it's possible to set the automatic or manually printing and clearing the partial total.

The automatic printing and clearing function allows to automatically clear the partial total, after the scale has carried out a number of consecutive totalisations (both in and out of tolerance) configurable through function **401** (combinable with the desired key, << **F.KEYS** >> step, **TECH.MAN.REF.**).

The relative weight data is also printed (see section 14).

13.10 PROGRESSIVES

13.10.1 ADDITIONAL VALUE

Through function **402**, combinable with the desired key (<< **F.KEYS** >> step, **TECH.MAN.REF.**), it's possible to set a value of up to 6 digits, which is summed to each totalisation, and can be recalled in the printing. The same value is linked independently to three total types (PARTIAL, GENERAL, and GRAND TOTAL), in other words, it is possible to print three different values which will be cleared with the clearing of the relative total.

13.10.2 PROGRESSIVE DIGITS

Through function **403**, combinable with the desired key (<< **F.KEYS** >> step, **TECH.MAN.REF.**), it's possible to set the number of digits with which the TICKET PROGRESSIVE and LOT PROGRESSIVE are printed.

The number of settable digits varies from 4 to 16, organised in this way:

- if the actual digits of the total are less than the number of digits set in this step, the difference is filled with some spaces.
- if the actual digits are greater than the number of digits set in this step, only the ones actually entered are taken into consideration (counting from right to left).

The alignment of the total fields is on the left.

NOTE: The number of settable digits DOES NOT INCLUDE the comma.

13.10.3 TICKET PROGRESSIVE

Through function **404**, combinable with the desired key (<< **F.KEYS** >> step, **TECH.MAN.REF.**), it's possible to modify or clear the TICKET PROGRESSIVE (up to 5 digits).

The TICKET PROGRESSIVE is a progressive number which increments of one UPON THE FIRST TOTALISATION SUBSEQUENT TO THE CLEARING OF THE PARTIAL TOTAL.

13.10.4 LOT PROGRESSIVE

Through function **405**, combinable with the desired key (<< **F.KEYS** >> step, **TECH.MAN.REF.**), one obtains the clearing of the AUTOMATIC LOT (up to 6 digits); before carrying out the actual clearing, one is asked to confirm or cancel the operation; confirm with **ENTER**.

The AUTOMATIC LOT is a progressive number which increments of one UPON THE FIRST TOTALISATION SUBSEQUENT TO THE CLEARING OF THE GENERAL TOTAL.

14. PRINTOUTS

The instrument is fitted with different print functions, which may be used while weighing, and of 30 print formats, in other words, 30 different memory storages, each of which contain a programmable printout.

The print executed by some of these functions depends on the print format linked to it; see the following section for the linkages.

The format linking function allows to execute various printouts, by changing the linked format each time.

The available functions are:

SIMPLE PRINTOUT:

- Programmable printout -

Through the PRINT key **F5** key one prints the linked format, **without executing the totalisation**.

With the APPROVED instrument:

- The printing works if there is a NET WEIGHT greater than zero or a NET WEIGHT lower than zero (in UNLOADING).
- The printout is reenabled depending on how the **F.mode >> rEACt** parameter has been programmed in the TECHNICAL SET-UP (**TECH.MAN.REF.**).
- The simple printout excludes the totalisation and viceversa.

With the NON APPROVED instrument:

- The printing works if there is a NET WEIGHT greater than zero or a NET WEIGHT lower than zero (in UNLOADING).
- The simple printout does not exclude the totalisation and is always active (the programming of the **F.mode >> rEACt** parameter of the TECHNICAL SET-UP **TECH.MAN.REF.** is not taken into consideration).

TOTALIZATION

- Programmable printout -

After a totalisation made with the **F6** key, also the printing of the linked format is executed.

For the totalisation conditions, see section 13.6.

PRINTING OF THE HEADING (upon the first executed totalisation)

- Programmable printout -

See section 14.2

PARTIAL TOTAL

- Programmable printout -

By pressing the **F8** key, the resetting of the PARTIAL TOTAL and the printing of the linked format are made.

Alternatively, it's possible to automatically execute the function, as described in section 13.2.9.

GENERAL TOTAL

- Programmable printout -

By pressing the **F9** key the resetting of the GENERAL TOTAL and the printing of the linked format are made.

GRAND TOTAL

- Programmable printout -

By pressing the **F10** key, the resetting of the GRAND TOTAL and the printing of the linked format are made.

TOTAL OF EACH HANDLED ARTICLE

- Programmable printout -

Through function **304**, combinable with the desired key (<< **F.KEYS** >> step, **TECH.MAN.REF.**), for each article whose net total shows to be greater than 0, the resetting of the relative ARTICLE TOTAL and the printing of the linked format are made

SELECTED ARTICLE TOTAL

- Programmable printout -

With the selected article, by pressing the **2ndF** and **F1** keys the resetting of the ARTICLE TOTAL is made and the linked format is printed.

LIST OF WEIGHS CONDITIONED BY THE ARTICLE

- Programmable printout -

To carry out this function, link the code **307** with the desired key, **TECH.MAN.REF.** The 4 linked formats are printed, in other words, the printing of the weighs' list conditioned by the selected **article**. To clear the weighs' list by selected article, link the code 308 to the desired key, **TECH.MAN.REF.** The indicator shows the message SurE? on the display and the CLEAR WEIGHS' LIST text on the LCD display; confirm with **ENTER** to clear the list of the weighs conditioned by article.

LIST OF WEIGHS CONDITIONED BY THE CUSTOMER

- Programmable printout -

To carry out this function, link the code **309** with the desired key, **TECH.MAN.REF.** The 4 linked formats are printed, in other words, the printing of the weighs' list conditioned by the selected **customer**. To clear the weighs' list by selected article, link the code 310 to the desired key, **TECH.MAN.REF.** The indicator shows the message SurE? on the display and the CLEAR WEIGHS' LIST text on the LCD display; confirm with **ENTER** to clear the list of the weighs conditioned by customer.

LIST OF ALL THE WEIGHS

- Programmable printout -

To carry out this function, link the code **311** with the desired key, **TECH.MAN.REF.** The 4 linked formats are printed, in other words, the printing of **all** the weighs' list. To clear the weighs' list by selected article, link the code 312 to the desired key, **TECH.MAN.REF.** The indicator shows the message SurE? on the display and the CLEAR WEIGHS' LIST text on the LCD display; confirm with **ENTER** to clear the list of all the weighs.

NOTE: The indicator keeps the **LAST** 1000 totalisations in storage. For further details on the print modes of the **weighs' lists** and for the configuration of the formats see section 7 – CONFIGURATION OF WEIGHS' LISTS of the **TECHNICAL MANUAL**.

RESULT OF THE CALCULATOR

- Programmable printout -

Once terminated the operation with "CALCULATOR" function the linked format is printed. See section **15.2**.

TOTAL OF EACH HANDLED CUSTOMER

- Programmable printout -

Through function **316**, combinable with the desired key (<< **F.KEYS** >> step, **TECH.MAN.REF.**), for each customer whose net total shows to be greater than 0, the resetting of the relative CUSTOMER TOTAL and the printing of the linked format are made.

SELECTED ARTICLE TOTAL

- Programmable printout -

With the selected customer, by pressing the **2ndF** and **F2** keys the resetting of the CUSTOMER TOTAL is made and the linked format is printed.

PRINTING OF THE DATABASE REPORT

- Fixed printout -

By pressing the "**F5**" key inside the databases it is possible to print a report of the ARTICLE DATABASE, CUSTOMER DATABASE, or TARE DATABASE (see sections 11.1.4, 11.2.4, 7.4.4).

N.B.:

- These printouts are not modifiable.
- The printing made with the **F5** key must be recalled within each single database.

14.1 LINKING OF THE FORMATS TO THE PRINT FUNCTIONS

Through function **200**, combinable with the desired key (<< **F.KEYS** >> step, **TECH.MAN.REF.**), one accesses the linking of the print formats (configurable in the **SEtuP** >> **SEriAL** >> **Prn.FMt** step **TECH.MAN.REF.**) to the programmable print functions:

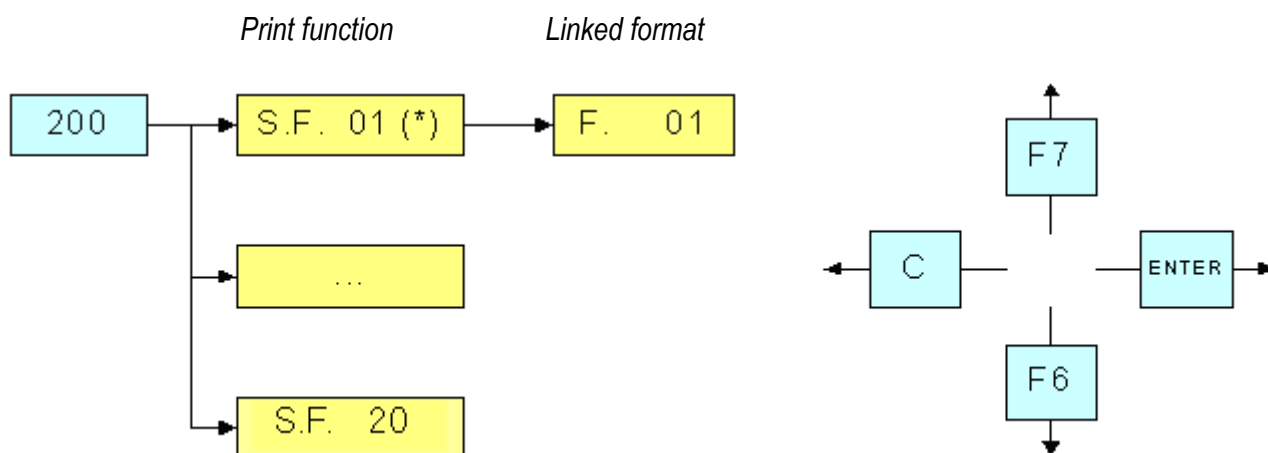

Print Functions	Key	Linked step
SIMPLE PRINTOUT	F5	S.F. 01
TOTALISATION	F6	S.F. 02
PARTIAL TOTAL	F8	S.F. 03
GENERAL TOTAL	F9	S.F. 04
GRAND TOTAL	F10	S.F. 05
HEADING OF THE FIRST TOTALISATION	F6	S.F. 06
TOTAL OF EACH HANDLED ARTICLE (recalls various times the printing of the selected article total)	Function 304 , combinable with the desired key (<< F.KEYS >> step, TECH.MAN.REF.)	S.F. 07
SELECTED ARTICLE TOTAL	2ndF + F1	S.F. 07
LIST OF WEIGHS CONDITIONED BY THE ARTICLE	Function 307 , combinable with the desired key (<< F.KEYS >> step, TECH.MAN.REF.)	S.F. 08 (list heading for selected article)
		S.F. 09 (single weigh selected article)
		S.F. 10 (sector end selected article)
		S.F. 11 (list end for selected article)
LIST OF WEIGHS CONDITIONED BY THE CUSTOMER	Function 309 , combinable with the desired key (<< F.KEYS >> step, TECH.MAN.REF.)	S.F. 12 (list heading for selected customer)
		S.F. 13 (single weigh selected customer)
		S.F. 14 (sector end selected customer)
		S.F. 15 (list end for selected customer)
LIST OF ALL THE WEIGHS	Automatic entry	S.F. 16 (list heading for all the weighs)
		S.F. 17 (single weigh for all the weighs)
		S.F. 18 (sector end for all the weighs)
		S.F. 19 (list end for all the weighs)
RESULT OF THE CALCULATOR (See section 15.2)	Automatic entry	S.F. 20
TOTAL OF EACH HANDLED CUSTOMER (recalls various times the printing of the selected article customer)	Function 316 , combinable with the desired key (<< F.KEYS >> step, TECH.MAN.REF.)	S.F. 21
SELECTED CUSTOMER TOTAL	2ndF + F2	S.F. 21
PRINT AT START-UP	Automatic entry	S.F. 22

The instrument is fitted with 30 print formats, in other words, 30 different storages, each of which contain a programmable printout.

The formats are programmable in the **SEtuP >> SEriAL >> Prn.FMt** step in the SET-UP environment (**TECH.MAN.REF.**).

It's possible to quickly link to each print function listed in the table to a stored format; this function allows also to execute various printouts with the same print function, changing the linked format from time to time.

TO LINK THE FORMAT:

- Recall function **200**, combinable with the desired key (<< **F.KEYS** >> step, **TECH.MAN.REF.**).

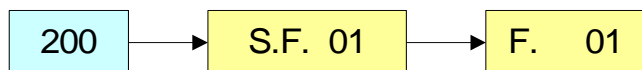

- The LCD display shows:

XX in which:

XX indicates the number of the function (from 01 onwards) to which the print format is linked.

- Select the print function (for example S.F. 01) through the arrow keys ▲ ▼ and press the **ENTER** key
- Once entered, the display shows:

XX in which:

XX indicates the number of the format to be linked to the function.

- Type the format number and press **ENTER**.

NOTE: In order to not link any format to a vector one should enter the number 00.

14.1.1 QUICK LINKING OF THE FORMATS

By linking the number of a specific print function to the function **200** (preamble function in the << **F.KEYS** >> step, **TECH.MAN.REF.**), it is possible to access directly to the modification of it with a direct key, for example F1 key to quickly link the S.F. 1, and F2 key to quickly link the S.F. 2.

Furthermore for some print functions the desired formats can be quickly linked by setting directly the corresponding code (function) to the desired key (<< **F.KEYS** >> step, **TECH.MAN.REF.**) without having to program the preamble:

CODE	QUICK LINKING FUNCTION	PRINT FUNCTION
200	Format linking to the Simple Printout (Prn.Fmt)	S.F. 01
201	Format Linking to the Totalisation (SND.FMT)	S.F. 02

TO QUICK LINK THE FORMAT:

- Recall the desired print function, by pressing the linked key (<< **F.KEYS** >> step, **TECH.MAN.REF.**).

- The LCD display shows:

XX in which:

XX indicates the number of the format to be linked.

- Type the format number and press **ENTER**.

NOTE: In order to no link any format to a print function one should enter the number 00.

14.2 FORMATTING HEADING PRINTOUT

If a format is linked to ("FIRST TOTALISATION HEADING") the pressing of **F6** upon the first totalization, will cause the printing of this format and then the format linked to the totalisation function.

The data which will be configured, allowing to create an independent print format which will be printed as a heading to the **first totalisation**, with the GENERAL TOTAL equal to zero. It is useful to print the COMPANY HEADING or the other DESCRIPTIONS, when it's not necessary to print these in each single accumulation operation.

14.3 REPETITION OF THE LAST EXECUTED PRINTOUT

By pressing in sequence the **2ndF** and **F5** keys the last executed printout is repeated; this function can not be reenabled.

14.4 DEFAULT PRINTING FORMATS

The **SetuP >> SerialL >> dEF.Prn** parameter of the set-up environment (**TECH.MAN.REF.**) allows to enable the standard printouts for the TPR printer.

NOTE: By enabling these printouts all the formatted print formats will be CANCELLED and the first 22 will be SUBSTITUTED by the standard formats, which automatically will be linked to the available print functions.

15. OTHER FUNCTIONS

15.1 CALCULATOR

Through function **114** combinable with the desired key (<< **F.KEYS** >> step, **TECH.MAN.REF.**), one enables the calculator function.

- **ADDITION**
- **MULTIPLICATION**
- **SUBTRACTION**

Procedure:

- Enter the first value using the numerical keyboard.
- Press **F1** to add, **F2** to multiply, **F3** to subtract the value.

TERMINATE THE OPERATION:

- **TYPE** the second value and **PRESS ENTER**: the result will be shown for a few seconds on the display.
- **TYPE** the second value and **PRESS TARE**: the result will be shown for a few seconds on the display and will be added (if an addition and multiplication) or subtracted (if a subtraction) to the current tare value.
- **PRESS 2nd F**: the NET weight on the scale will be used as a second value and the result will be shown for a few seconds on the display.

In the end the printing of the "CALCULATOR" will be executed anyway (See section 14 **PRINTOUTS**).

To disable the calculator function, press the **C** key.

HELP FUNCTION

By pressing at length the **. /HELP** key it is possible to see the list of the keys used in the calculator function.

If one wants to scroll the list of the keys in manual mode, it is possible to use the arrow keys (**F6** ▼ and **F7** ▲).

15.2 DISPLAY OF NET WEIGHT WITH SENSITIVITY X 10 (for testing use during calibration)

By pressing at length the **F2** key one will view the net weight with sensitivity times 10 (press again at length the **F2** key to return to the normal visualisation).

NOTES:

- **With approved indicator, the visualisation lasts about 5 seconds, after which it's disabled.**
- **The printout can only be done when the indicator has the standard sensitivity.**

15.3 SETTING DATE / TIME

By pressing at length the **F3** key it's possible to quickly access the setting from the date / time of the instrument:

DAY ⇒ **ENTER** ⇒ MONTH ⇒ **ENTER** ⇒ YEAR ⇒ **ENTER** ⇒ HOUR ⇒ **ENTER** ⇒ MINUTES ⇒ **ENTER**.

15.4 SET-POINT FUNCTION

The indicator is supplied with 4 outputs (optional) that can be used for different functions, besides, through the I/O expansion board (in the IO version) it is possible to use another 12.

In the **SEtuP >> outPut >> r.ConF** menu (**TECH.MAN.REF**) it is possible to set the characteristics of each output which will be used: normally open or normally closed; upon direct control or weight stability, with hysteresis or without, the functioning mode

It is also possible to set whether the enabling of the output excludes the check on the previous outputs (see the **SEtuP >> outPut >> r.ModE** parameter).

15.4.1 NORMAL FUNCTIONING MODE

By setting the **SEtuP >> outPut >> r.ModE** parameter on "norMAL", one configures the independent use of the outputs:

- the check is made on all the set outputs.
- the enabling of one of these does not cause the disabling of the others.

15.4.1.1 SETPOINT ON THE GROSS WEIGHT

Functioning with hysteresis (**rLiSt** "HYSTERESIS" parameter set as **iSt.on**)

By selecting this functioning mode the output function on the GROSS weight is activated; one enters two SETPOINTS for each output: a DISABLING one, which, when the gross weight is lower than it, disables the appropriate output; an ENABLING one, which, when the gross weight is greater or equal than it, it enables the appropriate output. Through function **202**, combinable with the desired key (<< **F.KEYS** >> step, **TECH.MAN.REF.**), the SET POINT values are entered (DISABLING and ENABLING) for each configured output:

- The display shows " S.1 on " (relay 1 ENABLING SETPOINT): press **ENTER**, enter the weight value with the keyboard and confirm with **ENTER** (use the **C** key to quickly zero the current value).
- The display shows " S.1 oFF " (relay 1 DISABLING SETPOINT): press **ENTER**, enter the weight value with the keyboard and confirm with **ENTER** (use the **C** key to quickly zero the current value).
- Proceed in the same way for the following outputs (if present).
- When finished programming the setpoints, exit with the C key.

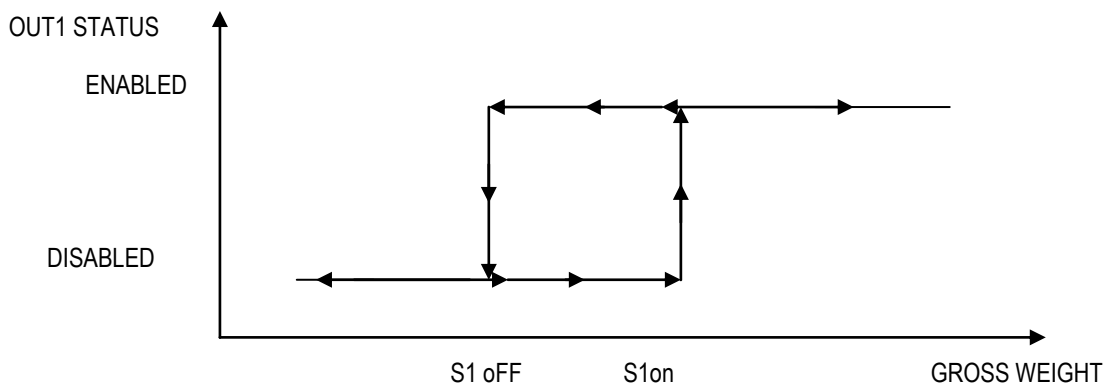

FUNCTIONING WITHOUT HYSTERESIS (**rLiSt** "HYSTERESIS" parameter set as **iSt.oFF**)

The operating mode is the same as the previous one, except that just one SETPOINT is entered for each output ("S.1 on"); for this purpose **the access to the " S.1 oFF " parameter is inhibited.**

NOTES

- The DISABLING SETPOINT must be less or equal to the ENABLING ones; if a value greater than the ENABLING one is entered and confirmed in the DISABLING SETPOINT, the indicator will set at 0 the setpoint, until a correct value is entered.
If a value lower than the DISABLING one is entered and confirmed in the ENABLING SETPOINT, that value is accepted, but the DISABLING SETPOINT is put at 0.
- The 0 value is valid on both the setpoint values.
- The SETPOINT check of the weight remains active on the present value even during the modification of the SET POINT, until the new value is confirmed.
- At start-up, the relays are managed from when the weight is displayed and these take on the configuration set in the set-up environment. These are not managed inside the technical set-up.
- In case of weight not valid (local or from remote scale) all the outputs will be disabled.

15.4.1.2 SETPOINT ON THE NET WEIGHT

By selecting this functioning mode the output function on the NET weight is enabled; the entry of the SETPOINTS and the specifications are the same as the functioning mode on the gross weight.

15.4.1.3 GROSS WEIGHT AT ZERO

By selecting this functioning mode the output function on the GROSS weight at 0 is enabled.

15.4.1.4 NET WEIGHT AT ZERO

By selecting this functioning mode the output function on the NET weight at 0 is enabled.

15.4.1.5 INSTABILITY

By selecting this functioning mode the output function on the unstable weight is enabled.

15.4.1.6 TOTALISATION

By selecting this functioning mode the output function is enabled when the totalisation has taken place; the output remains enabled until the totalisation is restored; in other words, by the passing by zero of the net weight or by weight instability (see **F.mode** >> **rEACt** parameter of the TECHNICAL SET-UP, **TECH.MAN.REF.**).

15.4.1.7 SETPOINT ON THE PARTIAL TOTAL

By selecting this functioning mode, the output function on the sum between the NET weight present on the scale and the accumulated net partial total is enabled; the entry of the SETPOINTS and the specifications are the same as the functioning mode on the gross weight.

15.4.1.8 SETPOINT ON THE GENERAL TOTAL

By selecting this functioning mode the output function on the sum between the NET weight present on the scale and the accumulated net general total is enabled; the entry of the SETPOINTS and the specifications are the same as the functioning mode on the gross weight.

15.4.1.9 SETPOINT ON THE GRAND TOTAL

By selecting this functioning mode the output function on the sum between the NET weight present on the scale and the accumulated net grand total is enabled; the entry of the SETPOINTS and the specifications are the same as the functioning mode on the gross weight.

15.4.1.10 SETPOINT ON THE NEGATIVE NET WEIGHT

By selecting this functioning mode the output function on the NET NEGATIVE weight is enabled; the entry of the SETPOINTS and the specifications are the same as the functioning mode on the gross weight.

Functioning with hysteresis (rLiSt “HYSTERESIS” parameter set as iSt.on)

By selecting this functioning mode the output function on the NEGATIVE NET weight is activated; one enters two NEGATIVE SETPOINTS for each output: a DISABLING one, which, when the NET weight is greater than it, disables the appropriate output; an ENABLING one, which, when the NET weight is lower or equal than it, it enables the appropriate output.

The entry and specifications are the same for the functioning mode on the gross weight.

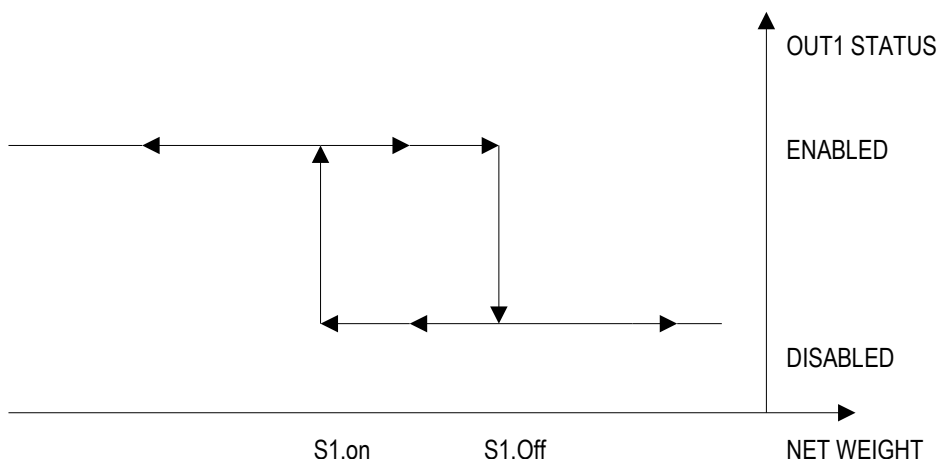

Functioning without hysteresis (rL.iSt "HYSTERESIS" parameter set as iSt.oFF)

The operating mode is the same as the previous one, except that just one SETPOINT is entered for each output ("S.1 on"); for this purpose **the access to the " S.1 oFF " parameter is inhibited.**

The entry and specifications are the same for the functioning mode on the gross weight.

15.4.2 EXCLUSIVE FUNCTIONING MODE

By setting the **SEtUP >> outPut >> r.ModE** parameter on "EXCLuS", one configures the exclusive use of the outputs:

- The check is made on all the set outputs starting from the last one (OUT 16) to the first one (OUT 1). When one of these is enabled the check on the previous ones is excluded.

By selecting this functioning mode and setting the set points in increasing order, one can create outputs activation ranges. Useful for the functioning with the control light for tolerance check.

Example:

OUTPUT	SETPOINT	ACTIVATION RANGE
OUT 1	1.000 kg	From 1.000 to 1.999
OUT 2	2.000 kg	From 2.000 to 2.999
OUT 3	3.000 kg	From 3.000 to 3.999
OUT 4	4.000 kg	From 4.000 onwards.

In this case, if the weight reaches 2.500 kg, ONLY THE OUTPUT2 IS ENABLED; if the weight reaches 4.500 kg, ONLY THE OUTPUT4 IS ENABLED.

15.4.3 QUICK MODIFICATION OF THE SETPOINTS

By linking the number of a specific setpoint to the function **202** (preamble function in the << **F.KEYS** >> step, **TECH.MAN.REF.**), it is possible to access directly to the modification of it with a direct key, for example F1 key to quickly modify the SETPOINT 1, and F2 key to quickly modify the SETPOINT 2.

15.4.4 FUNCTIONING OF CONTROL LIGHT

(only for CPWET)

The control light is connected to the relays 1 (**ORANGE LEDS**), 2 (**GREEN LEDS**) and 3 (**RED LEDS**). The function of each relay depends from the function set on the **SETUP→OUTPUT→R.CONF→RL.1÷3→RLFUNCT** step, **TECH.MAN.REF.**

15.5 DIAGNOSTIC PERIPHERALS

Through function **118** combinable with the desired key (<< **F.KEYS** >> step, **TECH.MAN.REF.**), one enables the diagnostic peripherals function.

The display shows:



STATUS	DESCRIPTION
ANALOGUE OUTPUT(A.O)	Analogue output value expressed as a percentage.
OUTPUTS (OUT)	Status output, non active (○) or active (●).
INPUTS (IN)	Status input, non active (⚡) or active (⚡).
SERIAL COMUNICATIOS (Tx Rx)	The serial communication is active with external device.
WEIGHT	Status of the weight: - 📊 with unloaded scale; - 📊 with unstable weight;
SCALE	Number of the active scale (example 📊, see section 5 SCALE SELECTION) and the relative weight loaded.

15.6 COM DATA DIAGNOSTIC

Through function **119** combinable with the desired key (<< **F.KEYS** >> step, **TECH.MAN.REF.**), one enables the Com data diagnostic function. The display shows:

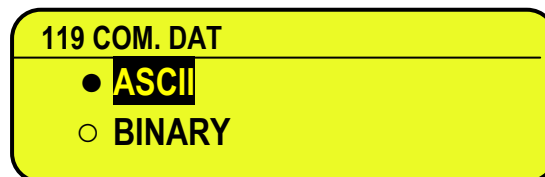
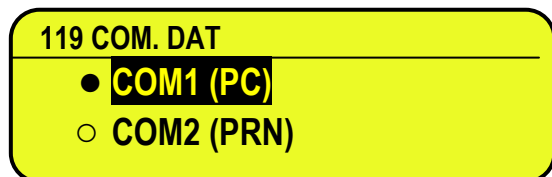

In the first screen one selects the port on which the diagnostic control should be executed. While in the second screen, one selects the code that one wants to use for viewing the data in transit.

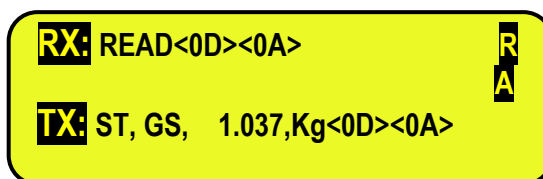

When the data on the RX and TX reception and transmission lines are correctly displayed, then the functioning of the relative serial line is considered to be correct.

NOTE: By pressing the **.HELP** key, it's possible to see the keys list used in the menu.

15.7 UNIT OF MEASURE CONVERSION

To carry out this function, link the 301 code to the desired key, **TECH.MAN.REF.**. The conversion of the unit of measure of the scale to pounds is made, and vice versa, and the weight is shown on display; the unit of measure in use is shown by the g / kg / t / F led pilot lights (F standing for pounds) of the graph bar.

Simple display functioning mode; by pressing the **SWITCH** key the conversion between the scale unit of measure and lb takes place and vice versa; the unit of measure in use will be shown by the following leds on the bar-graph: g / kg / t / F (F standing for pounds).

NOTES:

- The conversion takes place for any unit of measure set during the calibration.
- With APPROVED instrument the weight in pounds is displayed for 5 seconds, after which the display goes to the scale unit of measure.

16. ALIBI MEMORY

The alibi memory allows storing the executed weighs or the weights transmitted to the PC, to the printers and to all the non approved devices.

The stored values can then be recalled by the PC serial line or directly on the indicator's display for a following check.

The data filed with each weigh or upon each weight transmission is:

- Gross weight
- Tare
- Unit of measure
- Number of selected scale

The memorisation of a weigh takes place:

- **Following the reception of a command through the serial line,**

See section 16.2.1.

- **Upon the printing made with the F5 key or upon totalisation**

By setting the **SEtuP >> SEriAL >> CoMPrn >> ProtoC>>ALIBI** it will request if it effect the transmission of the net weight "TX.N.W" or the gross weight "TX.G.W" (**TECH.MAN.REF.**)

It's possible also to transmit the string (weigh/ID) on the PC port, by setting the **SEtuP >> SEriAL >> CoMPC >> ProtoC>>ALIBI** it will request if it effect the transmission of the net "TX.N.W" weight or the gross "TX.G.W" weight (**TECH.MAN.REF.**);

The string is transmitted in the same format of the string received in response to the "WEIGHT VALUE REQUEST WITH WEIGH ID" command, described in section 16.2.1

The identification of the weigh takes place through the ID code; a code is given to each weigh, allowing to find the weigh in the database.

If the weight can be saved in the alibi, the numeric ID will be substituted with the message "NO".

The ID has the following format:

< Rewriting number > — < Weigh number >

- Rewriting number: number of 5 digits which may go from 0 to 00255; it indicates the number of complete rewritings of the alibi memory.
- Weigh number: number of 6 digits which may go from 0 to 131071; it indicates the weigh number in the current rewriting of the alibi memory

With each storage the weigh number is increased of 000001; when this reaches the value 131071, it restarts from 000000 and the rewriting number increases of 00001.

If the weigh can not be saved in the alibi, the numeric ID will be substituted with the message "NO".

For example:

If the weigh which has been stored is the following:

"PIDST,1, 1.000kg, 1.000kg,00126-131071"

the following will be:

"PIDST,1, 1.000kg, 1.000kg,00127-000000"

NOTE: it's possible to read the last 131071 weighs.

16.1 READING OF THE WEIGHS CARRIED OUT

Through function **420**, combinable with the desired key (<< **F.KEYS** >> step, **TECH.MAN.REF.**) it's possible to read a carried out weigh:

first enter the rewriting number of the Alibi memory (rEW.id), confirm with **ENTER**, and then enter the weigh number (id) and press **ENTER**. The ID is accepted only if valid.

If the alibi memory is empty the message "EMPTY" appears on the display for a few instants; if the ID code entered is not valid, the "no id" message appears for a few instants, and then one exits the step.

By entering a valid ID code, the display shows the following data, selectable through the arrow keys ▲ ▼ :

Ch.X in which X is the selected channel number (from 0 to 4)

Gross weight value with unit of measure;

Tare weight value with unit of measure;

Press **C** to exit the reading state of the weighs.

NOTE: It is possible to read the weigh carried out also through the PC serial line (see the "WEIGH READING" serial command in the following section).

16.2 SERIAL PROTOCOL FOR MANAGING THE ALIBI MEMORY:

!! IMPORTANT !!

If the serial commands are transmitted in the format:

<ESC> command <STX>

in which: <ESC> is the ASCII decimal 27 character

<STX> is the ASCII decimal 02 character

Also the relative answer will be:

<ESC> string <STX>

16.2.1 REQUEST WEIGHT VALUE WITH WEIGH ID

The command which allows saving the weight in the alibi memory and the transmission is:

<II>PID<CRLF>

< II > = machine code, only if functioning in 485

PID = saving command of the weight data in the alibi memory

CR = ASCII 13 decimal code

LF = ASCII 10 decimal code

If the gross weight is equal or greater than zero and stable, the instrument will save the weight on the belt in the alibi memory.

And the PID string (weight/id) will be transmitted on the PC port; this is described in the following section.

16.2.2 STRING FORMAT (WEIGHT/ID)

The PID string contains all the information regarding the executed weigh.

DESCRIPTION OF THE PID STRING:

<ESC>[II]PIDSS,B,LLLLLLLLLUU,YYTTTTTTTTTUU,(ID | NO) <CR or CRLF>

in which:	[II]	485 address (only in the case of 485 transmission mode)
	SS	US instable weight ST stable weight OL weight out of range (greater) UL weight out of range (lower)
	,	comma character, ASCII 044
	B	number of selected channel
	,	comma character, ASCII 044
	LLLLLLLLLL	gross weight on 10 digits
	UU	unit of measure
	,	comma character, ASCII 044
	YY	2 spaces in the case of null tare or semiautomatic tare, PT in the case of preset tare
	TTTTTTTTTT	tare weight on 10 digits
	UU	unit of measure
	,	comma character, ASCII 044
	ID	XXXXX-YYYYYY or "NO": weigh not stored in the alibi memory; the gross weight is negative or unstable.
	<CR o CRLF>	Terminator, ASCII 13 and ASCII 10 characters

16.2.3 WEIGH READING

Command:

[II]ALRDXXXX-YYYYYY <CR o CRLF>

in which	[II]	485 address (only in the case of 485 transmission mode)
	XXXXX	rewriting number, from 0 up to 255.
	-	ASCII 045 character
	YYYYYY	ID code
	<CR o CRLF>	terminator, ASCII 13 and ASCII 10 characters

Instrument answer:

[II]B,LLLLLLLLLUU,YYTTTTTTTTTUU <CR o CRLF>

in which:	[II]	485 address (only in the case of 485 transmission mode)
	B	number of selected channel
	,	comma character, ASCII 044
	LLLLLLLLLL	gross weight on 10 digits
	UU	unit of measure
	,	comma character, ASCII 044
	YY	2 spaces in the case of null tare or semi automatic tare, PT in the case of preset tare
	TTTTTTTTTT	tare weight on 10 digits
	<CR o CRLF>	Terminator, ASCII 13 and ASCII 10 characters

16.2.4 ALIBI MEMORY CANCELLATION (only with non approved instrument)

Command:

[II]ALDL <CR o CRLF>

in which	[II]	485 address (only in the case of 485 transmission mode)
----------	------	---

Instrument answer:

[II]ALDLOK <CR o CRLF>	if the cancellation has been carried out effectively
[II]ALDLNO <CR o CRLF>	if the cancellation has not been carried out effectively

17. MESSAGES

While using the indicator, it is possible to incur into the following errors:

17.1 INSIDE THE SET-UP OR MENU OR AT START-UP

MESSAGE	DESCRIPTION
C.Err. – 8.03	When carrying out the multirange or multidivisional calibration, the ranges have not been entered in an increasing manner (RANGE 1 < RANGE 2 < RANGE 3).
C.Err. – 36 CALIBRATION ERROR	During the calibration some internal negative points have been calculated: <ul style="list-style-type: none"> - the calibration point is less than the zero point. - the signal is negative (check the connections)
Er – 37 / alternately with No.Cal CALIBRATION ERROR	During the calibration some internal points less than the minimum value have been calculated: <ul style="list-style-type: none"> - the calibration point is equal to the zero point. - A capacity too high in relation to the division has been set.
Err. – 38 NO CALIBRATION	Range not valid: please check that RANGE 1 < RANGE 2 < RANGE 3.
Er – 39 NO CALIBRATION	Invalid calibration range number (there is the value 0 or values greater than 3); one must execute a TECHNICAL DEFAULT (dFLt.t parameter of the SET-UP environment), if not already executed previously, and carefully carry out the calibration.
Er – 40	The value 0 is in the “range 1” parameter of the calibration; one must execute a TECHNICAL DEFAULT (dFLt.t parameter of the SET-UP environment) and carefully carry out the calibration.
Er – 41	The value 0 is in the “diV 1” parameter of the calibration; one must execute a TECHNICAL DEFAULT (dFLt.t parameter of the SET-UP environment) and carefully carry out the calibration.
Err. – 72	Equalization coefficient adjustment not allowed because a too low sample weight has been used.
Err. – 85	Equalization coefficient adjustment not allowed because the instrument has not been calibrated.
ErPnt	During the acquisition of a calibration point, a null value from the converter has been read.
hW-Err	HARDWARE ERROR: software not compatible with the installed hardware; the hardware expansion component is missing which allows the software to function.
EXITING SETUP: SAVE ?	The instrument requests the saving when exiting the set-up; press ENTER to confirm or C to not continue..
SURE?	The instrument requests a confirmation before proceeding: press ENTER to confirm or C to not continue.
Error	Generic error. Possible motives can be: <ul style="list-style-type: none"> - Division not valid: please check that DIVISION 1 < DIVISION 2 < DIVISION 3; - An error has taken place in the connection, configuration, equalisation, calibration of the cells, etc.
EXECUTION AUTOZERO	“autozero at start-up” function is active (see section 3.3)

17.2 IN WEIGHING

MESSAGE	DESCRIPTION
NON VALID OR UNSTABLE WEIGHT	Printing or totalisation not possible with weight at 0, negative, unstable, or out of the totalisation field.
NO ZERO CROSS OR INSTABILITY	Printing or totalisation not possible without having the weight pass by the net zero or by instability.
*** POWER OFF ***	Turning off of the instrument through the key (see section 3.3).
- - - - - - OUT CAPACITY ! -	<p>OVERLOAD The weight is 9 divisions above the Maximum Capacity. Approved instrument: the weight is under the gross zero (-100 divisions).</p> <p>OR</p> <p>UNDERLOAD - Approved instrument: The weight is under the gross zero (-100 divisions). - Non approved instrument: The weight is under the gross zero (- capacity – 9 divisions).</p>
ZERO	Execution of scale zero (see section 6).
TARE	Tare execution (see section 7).
CLEAR	Tare cancellation (see section 7.4.3)
PRN-ON	Turning on printer for maintenance (see section 3.4).
GROSS	Visualisation of the gross weight.
NET	Visualisation of the net weight.
LOCK	Tare lock or enabled keyboard function.
UNLOCK	Tare lock or disabled keyboard function.
ENTER=RETRY C=CANCEL PRINTOUT	Error during printing: press ENTER to restore the printing or C to cancel it and repeat it through the procedure described in section 14.3.
PRINTER ERROR: CHECK THE CTS!	Error during the printing: totalisation not possible or printing not executed / finished.
USER - PRESS KEY	See section 12.

DECLARATION OF CONFORMITY

This device conforms to the essential standards and norms relative to the applicable European regulations. The Declaration of conformity is available in the web site www.diniargeo.com

WARRANTY

The TWO-YEAR warranty period begins on the day the instrument is delivered. It includes spare parts and labour for repairs at no charge if the INSTRUMENTS ARE RETURNED prepaid to the DEALER'S PLACE OF BUSINESS. Warranty covers all defects NOT attributable to the Customer (so are not included in the warranty, failures resulting from improper use) and NOT caused during transport.

If on site service is requested (or necessary), for any reason, where the instrument is used, the Customer will pay for all of the service technician's costs: travel time and expenses plus room and board (if any).

The customer pays for shipping costs (both ways), if the instrument is shipped to the DEALER or manufacturer for repair.

The WARRANTY is VOIDED if faults occur due to work done by unauthorised personnel or due to connections to equipment installed by others or incorrect connection to the power supply.

This warranty DOES NOT provide for any compensation for losses or damages, direct or indirect, incurred by the Customer due to complete or partial failure of instruments or systems sold, even during the warranty period.

AUTHORISED SERVICE CENTRE STAMP

